

ISSN NO  
2454-7719

# International Journal of Computer Research & Technology ( IJCRT )

A Peer Reviewed Half Yearly Research Journal

Vol -6 Issue -1  
January-June,2020

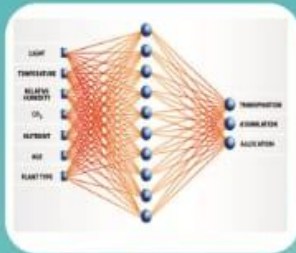

## Special Issue

Proceeding of the 1<sup>st</sup> Online National E-Conference on  
"Ongoing Research On Computer Science"  
held on 27<sup>th</sup> May 2020.

Editor in Chief

Dr.B.H.Barhate

॥ विद्या दानम् महत् पुण्यम् ॥

Tapti Education Society's

Dept. of Computer Science and Information Technology

**Bhusawal Arts Science & P.O.Nahata Commerce College,  
Bhusawal - 425 201 Maharashtra**

NAAC Reaccredited : Third Cycle Grade 'A' ( CGPA : 3.30)

UGC recognised ' College with Potential for Excellence for II nd Phase Effective from 2014 to 2019

Affiliated to Kavayitri Bahinabai Chaudhari North Maharashtra University, Jalgaon



Special issue on  
Proceeding of 1<sup>st</sup> Online National  
E-Conference on "Ongoing  
Research on Computer Science"

**Held on 27<sup>th</sup> May 2020**

**Organized By**

---



**Department of Computer Science & I.T.,**  
TES'S Bhusawal Arts, Science & P. O. Nahata Comm. College,  
Jamner Road, Bhusawal Dist-Jalgaon (MS) Pin-425201. (INDIA)

### About Publisher of IJCRT

Bhusawal, as recalled and noted down in records has a prominent place on the map of the nation; proudly housing two ordnance factories, a thermal power station in the region, and itself being one of the major railway junctions of Central Railway from where, residents proudly say, you may visit any corner of India. A mixture of farmers, tribal people from adjoining areas with the servants from all over India, Bhusawal serves as a slice of the nation; and honorably has unity in diversity. It is 25 kms away from the district, Jalgaon, famous as a city of gold; and few kms away from Yawal and Raver tehsils, famous all over nation for bananas. It is the only 'A' graded Municipal Corporation in the district. Another identification as well as benefit of the city is that it is situated at the banks of the Tapi river, the only river that flows from east to west. The city of Bhusawal has been a home place for the British authorities, and it is famous for railways since British rule. It is historically remarkable for the grave of Major Robert Gill, who invented world famous Ajanta caves; and for the tomb of Sant Gadge baba, a famous and truly a leading social reformer in Maharashtra. It is believed that the parental home of Rani Laxmibai (famous as Queen of Jhansi) is situated at Parola, 50 kms away from the city. Bhusawal is also famous for many mythological stories like that of Shravana, coming from Ramayana who is said to be killed at Hartala, which is near to the city. Besides, the city was once famous in Bollywood for film distribution companies. The world famous Ajanta caves are just 60 kms away from the city.

Summing up the physiognomies of the city, Bhusawal stands as a glorious city in the eyes of everyone. However, it was the time- besides all assets of the city- when Bhusawal was a degenerated city in terms of higher education even after a long time from independence. There were few schools imparting high school level education but none of the colleges. It was only in 1958, under the motivation of Late Hon'ble Madhukarrao Chaudhari, ex-speaker of Maharashtra Legislative Assembly, a group of social well-wishers came together and established the Tapti Education Society in 1958. Simply having the wish in mind to provide potential students higher education facilities near their home, they started the Bhusawal College of Arts and Commerce in 1963. Their philanthropic view may be seen in the motto: *Vidyadanammahatpunyam*. Yet difficulties were innumerable. The college with two faculties was started in the place of rent of a high school in the city.

It is wisely said that *vidyadanamis mahatpunyam*. The dedicated faculty, the sublime view of the management soon started to produce good academicians. Inspired by the results the trust purchased a barren land of 7 acres out of the city which is soon to be developed as a centre of imparting quality higher education in the area. The barren land with sustaining hard work, and devotion was then transferred into a naturally beautiful campus. The college is then shifted to a new place in 1972 with the introduction of Science stream. The philanthropist Late Mr. Poonamchand Nahata donated to the college, hence the college is renamed- and which today itself is a brand- as Bhusawal Arts, Science and Poonamchand Omkardas Nahata Commerce College, Bhusawal.

The college is then marching forward with a goal to **creatively contribute the society through the pursuit of learning at higher level of excellence**. The institute has contributed in many ways for economic, social and cultural uplift of the society by offering quality education. Since the inception it has been known for academic excellence, inventive pursuits and athletic dynamism. The college is a multi-stream institute catering to the needs of the young minds primarily from the rural areas. Our society runs not only the college but also the Institute of Management and Career Development and much-sought Tapti Public School (affiliated to CBSE Board, New Delhi) within a minimum space of 7.3 acres. The institute is developing vertically in all of the fields.

The Tapti Education Society's Bhusawal Arts, Science and P. O. Nahata Commerce College was accredited as **four stars** in 2001, reaccredited as '**A**' Grade with CGPA 3.28 in 2008 **and recently reaccredited 3<sup>rd</sup> cycle as 'A' Grade with CGPA 3.30 in 2015** as the **first College** in North Maharashtra University jurisdiction. It is also the first college to volunteer for the third cycle of accreditation in the jurisdiction of the university. It is also recognized by UGC as **College with Potential for Excellence**. Recently, the society is certified as ISO 9001:2008 institute. Our institute is one of the renowned institutes in the adjoining area. We welcomed the upcoming students from rural areas who made remarkable progress and set theirs and college's image in society. Many of the students of this institute secure top position in various fields. This make us feel great. The college achieves 'A' grade in three subsequent cycles of Re-accreditations and it brings the college towards autonomous status.

Initially the college was affiliated to the Pune University, and got permanent affiliation in 1990. Since the inception of North Maharashtra University in 1991, the college is permanently affiliated to the same. The university spreads all over three districts: Jalgaon; Dhule; and Nandurbar, being on the boundaries of Gujrat and Maharashtra, and one being the district of tribal people. The university is trying hard to uplift the downtrodden, while keeping in touch with the rapidly changing world. Last but not least, the college has the advantages of developing youth coming from rural area, and forming them into sensible youth as they are mixed in the cosmopolitan society. The college is aware that every coin has two sides: hence students coming from rural areas have inferiority complex, their vernacular background being most disadvantage for them. The college has faced challenges to improve their communication skills, to boost their confidence to bring them into modern current while making them aware of great Indian culture. As recently, the college has celebrated its golden jubilee, it will be a golden, in fact a platinum moment for us when the students coming from different backgrounds will be essentially Indian serving for the welfare of humanity. With this view the college is making progress towards quality excellence so that it will be a lead college that will stand as a lighthouse for the confused.

**Editor in chief**

**Dr. B. H. Barhate**

*Vice Principal, IQAC Coordinator and  
H.O.D. Computer Science and I.T.*

TES'S, Bhusawal Arts, Science and P. O. Nahata Commerce College, Bhusawal (M.S.)

**Managing Editors**

**Prof. Harshal V. Patil**

*Asst. Professor, TES's Bhusawal Arts Science & P.  
O. Nahata Comm. College Bhusawal*

**Prof. S. S. Salunke**

*Librarian  
S.V.P. College, Ainpur (MS)*

**Editorial Board**

**Dr. M. V. Waykole**

*Principal,  
TES's, BhusawalArst, Science and  
P. O. Nahata Commerce. College, Bhusawal  
Dist-Jalgaon (M.S)*

**Dr. A. N. Patil**

*Principal,  
VasantnaoNaik Arts, Science and  
Commerce. College, Shahada,  
Dist- Nandurbar( M.S).*

**Mr. Parag U. Bhalchandra**

*Assistant Professor,  
School of Computational Sciences,  
SRTM University, Nanded ( M.S)*

**Dr. Sameer P. Narkhede**

*Associate Professor,  
School of Management Studies,  
North Maharashtra University, Jalgaon (M.S)*

**Dr. RakeshDeore**

*Assistant Professor,  
SSVPS'S Science College,  
Dhule (M.S)*

**Mrs. Hemalata P. Patil.**

*Director,  
School of Computer Science,  
M. J. College, Jalgaon (M.S)*

**Dr.G.R.Wani**

*Associate Professor,  
Department Of Computer Science and I.T.  
TES'S, Bhusawal Arts, Science and P. O.  
NahataCommerce College, Bhusawal. (M.S)*

**Dr. Gouri M. Patil**

*Assistant Professor,  
Department Of Computer Science and I.T.  
TES's, Bhusawal Arts, Sci. and P. O. Nahata  
Commerce College, Bhusawal (M.S.)*

**Dr. Swati P. Phalak.**

*Assistant Professor,  
Department Of Computer Science and I.T.  
TES's, Bhusawal Arts, Sci. and P. O. Nahata Commerce College, Bhusawal (M.S.)*

**Published By**

Tapti Education Society's

Dept. of Computer Science and I. T.

Bhusawal Arts, Science and P. O. Nahata Commerce College, Bhusawal.

Contact 9890966830

Email: [ijcrtcs@gmail.com](mailto:ijcrtcs@gmail.com)

Website: [basponcollege.org](http://basponcollege.org)

---

**The International Journal of Computer Research and Technology "IJCRT" is issued half yearly.**

**The College assumes no responsibility for the statements and opinions advanced by contributors.**

---

**©2020, Bhusawal Arts, Science and P. O. Nahata Commerce College, Bhusawal, Dist-Jalgaon (MS) India.**

---

**Online National E – Conference on  
“Ongoing Research in Computer Science” on 27<sup>th</sup> May 2020  
Organizing Committee**

---

**Patrons**

**Dr. Mohan Phalak**  
President,  
Tapti Education Society, Bhusawal

**Mr. Vishnu Chaudhari**  
Secretary,  
Tapti Education Society, Bhusawal

**Mr. Mahesh Phalak**  
Chairman,  
Tapti Education Society, Bhusawal

**Mr. Sanjaykumar Nahata**  
Treasurer,  
Tapti Education Society, Bhusawal

**Co-Patrons**

<p style="text-align: center;"><b>Dr. S. V. Patil</b> Vice Principal, BASPONC College, Bhusawal</p>	<p style="text-align: center;"><b>Prof. Dr. M. V. Waykole</b> Principal, BASPONC College, Bhusawal</p> <p style="text-align: center;"><b>Dr. A. D. Goswami</b> Vice-Principal, BASPONC College, Bhusawal</p>	<p style="text-align: center;"><b>Dr. N. E. Bhangale</b> Vice-Principal, BASPONC College, Bhusawal</p>
---	--	--

---

**Organizing Secretary**

**Prof. Dr. B. H. Barhate**  
Vice-Principal, IQAC Coordinator, HOD of Computer Science  
BASPONC College, Bhusawal  
Mobile: +91-9890966830

**Coordinator**

**Prof. Dr. G. R. Wani**  
Associate. Prof., BASPONC College, Bhusawal.

**Organizing Committee Members**

Prof. Dr. Gouri M. Patil	Prof. Harshal V. Patil
Prof. Dr. Swati P. Phalak	Prof. Poonam M. Mahajan
Mr. Vinay M. Chaudhari	Mr. Kishor Narkhede
All Teaching and Non-Teaching Staff of DOCS, BASPONC College, Bhusawal	

## INDEX

Sr. No	Research Paper Title	Page No.
1	Recognition of Marathi Numerals using Pixel Density Features and Multiple Neural Networks. <i>Aditya A. Jinturkar, Prakash B. Khanale</i>	1 to3
2	Online Education: An Effective Way to Learn <i>Suresh J. Raut</i>	4 to 6
3	Virtual data modifications using linear or nonlinear mathematical Algorithm to enlarge available information of covid 19 with hypersphere, Euclidean <i>Vishal Joshi, Jitendra Sheetlani</i>	7 to 10
4	THE ROLE OF LEARNING ANALYTIC IN EDUCATION <i>Vyankat Muunde, Dr.Binod Kumar, Dr.Shailaja Shirwaikar</i>	11 to 14
5	Impact of Fog Computing in Medical Service delivery sector <i>Er. Sandeep Kumar Bothra, Dr. Yogendar Kumar Verma, Aleem Khan</i>	15 to 19
6	IoT Applications Impact on Big Data: A Survey <i>Girish B. Desale, Atul S. Patil</i>	20 to 23
7	Performance assessment of classification techniques using Weka tool <i>Mr. Anand J. Maheshwari, Dr. G.R.Wani</i>	24 to 27
8	Role of Information Technology in E- Commerce <i>Mukesh Kumar</i>	28 to 32
9	Review and Study of Big Data Analytics it's Life Cycles and Tools <i>Dr. Bhojaraj H. Barhate</i>	33 to 35
10	Smart Farming using IOT <i>Priyanka Vijay Barhate, Karishma I. Kale</i>	36 to 38
11	An Overview of Blockchain Technology in Education System <i>Vasundhara R. Fegade</i>	39 to 40
12	Overview of Learning Management System in Higher Education <i>Harshal V. Patil, Dr. Bhojaraj H. Barhate</i>	41 to 45
13	Decision Support System :A Better Tool For Managing E-Business <i>Renu Patria</i>	46 to 47
14	Performance based analysis of various image segmentation techniques <i>Shubhangi K. Patil, Dr. B. H. Barhate, Dr. Gouri M. Patil</i>	48 to 50
15	Web accessibility issues and challenges for blind Person <i>Vaishali A. Patil, Prof. Harshal V. Patil</i>	51 to 55
16	An overview of different Steganography and Image Steganography techniques. <i>Rakesh KishorRane, Dr.Bhojraj H. Barhate</i>	56 to 58
17	Data Manning Techniques and Applications <i>Ankita Sanjay Deo, Divya Deepak Joshi, Hansraj M. Patil</i>	59 to 61
18	Conceptual Design Approach of Active Stream Data Warehouses <i>V P Mahajan, Dr. B H Barhate</i>	62 to 65
19	A Pulse Based Automated System Review for Nadi Parikshan <i>Vandana Chaudhari, Dr. Manoj Patil</i>	66 to 67
20	A Review study on: How Artificial Intelligence can help Businesses <i>Yogesh N. Chaudhari, Dr. B.H.Barhate</i>	68 to 71
21	XAMARIN: OVER VIEW OF CROSS PLATFORM MOBILE APP DEVELOPMENT <i>Poonam M. Mahajan</i>	72 to 75
22	A Review: Artificial Intelligence vs Human Intelligence Man vs. Machine <i>Archana P. Bhalerao</i>	76 to 78
23	IoT in Disaster Management for COVID-19 <i>Dr. Gouri M. Patil</i>	79 to 81

24	Humanoid Robot: A Review of the Architecture, Applications and Future Approaches <i>Pooja A. Rathi</i>	82 to 85
25	Document Noise and removal methods <i>Lubdha Milind Bendale</i>	86 to 90
26	COVID-19 Is As An Opportunity To Indian Railway For Development <i>Smita N. Bendale</i>	91 to 92
27	Impact of Covid - 19 on Ice cream and Cold drinks business <i>Khilesh S. Patil, Sapana R. Kolhe</i>	93 to 94
28	Study of current strategy of vegetables traders of market <i>Khilesh S. Patil, Jayshree A. Chaudhari</i>	95 to 97
29	Recent Trends, Opportunities and Models in E-commerce <i>Varsha G. Patil</i>	98 to 100
30	वैश्वीकरण के परिप्रेक्ष्य में जनसंचार माध्यमों में हिन्दी भाषा :विकास की दिशाएं एवं चुनौतियाँ <i>Dr. Rupali Chaudhari</i>	101 to 103

## Recognition of Marathi Numerals using Pixel Density Features and Multiple Neural Networks

Aditya A. Jinturkar<sup>1</sup>

<sup>1</sup> Assistant Professor, SIES College, Nerul

[jinturkaraditya@gmail.com](mailto:jinturkaraditya@gmail.com)

Prakash B. Khanale<sup>2</sup>

<sup>2</sup> Professor, D.S.M. College, Parbhani

[prakashkhanale@gmail.com](mailto:prakashkhanale@gmail.com)

### ABSTRACT:

*In Multi-lingual Countries like India; Languages have influenced every part of Human life. With the Advent of Computers; recognition of handwritten documents through computers has been a major area of research in Pattern Recognition. There is a research carried out on various Indian languages such as Hindi, Tamil, Telugu, Bangla as well as Marathi. Research Work in Marathi Handwritten Recognition has gain momentum in the last few years. In this paper; the problem of Marathi Handwritten numerals is discussed. Pixel Density Features were used in the Feature Extraction module. In Classification Module; two mostly used Neural Network models namely Feed Forward and Pattern Net have been used and their performance analyzed.*

**Keywords:** Pattern recognition, Numeral Recognition, Computer Vision, Feature Extraction, soft computing, Neural Network.

### Introduction

Handwriting recognition is an area under Pattern recognition domain in which input numerals are classified as one of K classes. [1-2] It has potential applications in recognizing Postal Code, Bank account numbers and Vehicle Number Plate. Generic HNR systems has 3 main modules: Preprocessing, Feature extraction and Recognition. Preprocessing phase deals with Digital Image processing operations on input data that makes it ready for further tasks. Feature extraction phase gets relevant information from input data required for pattern recognition and discards any redundant information present. Recognition phase performs job of classifying input pattern into its correct class.

A number of Pattern recognition models have been developed for different scripts using classifiers such as K nearest neighbor, Artificial Neural Networks, Support vector Machines and many others. When we compare Research in Non-Indic Scripts with Indian scripts we find that there is still large scope for research on Indian Scripts in many aspects.

### Marathi Language

Recognition of Marathi numerals is a less researched area and there is a large scope for research in this particular domain. The recognition of numeral recognition is a major step in language understanding. Recognition of Marathi numerals is a complex task due to variation among people in writing style, shape, strokes, etc. Some systems have been developed for numeral and character recognition by researchers. The Marathi Language is based on Devanagari script and numerals are as shown in figure 1.



Fig. 1: Marathi Numerals

However; in the case of handwritten numerals; they are affected by people's style of writing as shown in figure 2.

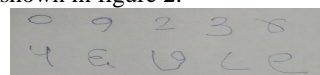

Fig. 2: Handwritten Marathi Numerals

Due to variations in writing; handwritten numerals are affected by noise. Therefore to recognize these numerals must be firstly preprocessed and then the neural network can recognize it.

### Related Work

In paper [3] a large amount of research is going on in the area of numeral recognition all over the world. But, Marathi numerals recognition is still a challenging job because of variety in writing, mixing of other script numerals, etc. Here; we have reviewed research in the area of numeral recognition.

In paper [4] Problem of Nonexistence of the standard database in recognition of handwritten Indian scripts is discussed. Any work in the area of pattern recognition needs a benchmark database on which results can be tested. Ujjwal Bhattacharya et al. have developed two databases for two Indian scripts i.e. Devanagari and Bangla. These databases include 22,556 and 23,392 numerals of Devanagari and Bangla scripts respectively. Authors have discussed problems in the recognition of Indian languages.



Many times while writing information, people write some numerals in English and others in the local language. For such a mixed-script problem, a multistage recognition scheme using Wavelet and MLP classifiers has been developed by the authors. This scheme is implemented on three scripts namely Devanagari, Bangla, and English. Experimental results show that the multistage recognition scheme gives better results.

In paper [5] pattern recognition problems such as character recognition, high classification accuracy, and resistance to non-characters are requirements from classifiers. Many statistical techniques and neural networks are used for the task of pattern recognition. In this paper, authors have proposed discriminative learning quadratic discriminant function (DLQDF) function. DLQDF is mainly designed for segmentation based classification. This classifier gives similar results as that of neural classifier MLP for numeral string recognition.

In paper [6] 100 samples of handwritten Devanagari numerals 0-9 have been collected from 10 different persons. After pre-processing these samples undergoes morphological processing, and then the database is created. There were three steps used for feature extraction of these numerals: measurement of extreme coordinates, grid computation, and then digitization of numerals. This feature vector then trained with a multilayer neural network.

### Proposed Method

In this work; an attempt has been made to recognize Marathi numerals using different Artificial Neural Network Models. The architecture of the proposed system is as shown in figure 3.

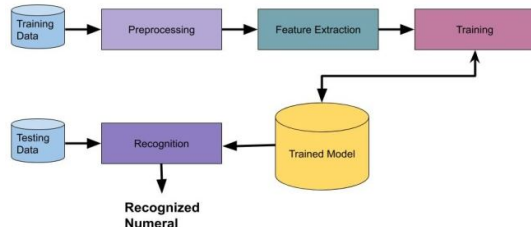

Fig. 3: Proposed Recognition System

### Preprocessing

This is the first stage in which the input image is subjected to various low-level operations so that the input image will be ready for further processing. Proposed Work includes the following preprocessing operations.

#### Conversion to Grayscale

Numeral image that we input to the system is of type RGB. It is firstly converted into an intensity image using following equation:

$$\text{Gray value at } (i, j) = 0.2989 * R(i, j) + 0.5870 * G(i, j) + 0.1140 * B(i, j) \quad (1)$$

#### Grayscale to Binary

The grayscale image is then further converted into Binary image using Otsu's Method. Otsu's method is well known for its use in Automatic image thresholding.

$$\sigma_w^2 = w_0(t)\sigma_0^2(t) + w_1(t)\sigma_1^2(t) \quad (2)$$

Where  $w_0$  and  $w_1$  are the probabilities of two classes separated by threshold  $t$ .

### Feature Extraction

Feature extraction is one of the crucial stages in any pattern recognition problem. In this stage; important characteristics of input sample which highlight its uniqueness among other samples belonging to different classes are extracted. In this way; it is a sort of dimension reduction technique. There are various feature extraction techniques used by researchers including Chain Code, Distance Measures, Fourier Descriptors, and many others. In this work; we have extracted Pixel density Features from input samples. Pixel Density Feature is simple and can be extracted with the help of minimum computations. This feature vector is then given to the neural network for training purposes.

### Recognition

In Recognizer module; we have used Two Artificial Neural Network Models namely Feedforward neural network and Pattern Recognition Neural Network. Both models are widely used in this area. Their performance varies with Training data, Number of Hidden layer neurons, Feature extraction technique used, etc. In this work; a performance of both models have been tested on given data. This network is trained so that it can handle noisy handwritten numerals efficiently.

### Experiments and Results

The proposed Method successfully implemented on the well-known CMATER database of numerals. [7-12] CMATERdb is the pattern recognition database repository created at the Center for Microprocessor Applications for Training Education and Research (CMATER) research laboratory, Jadavpur University, Kolkata, INDIA.

This database is free for all non-commercial uses. 180 samples were taken from the database and were tested by both neural Networks. The following table shows statistics of ANN models used and recognition accuracy. We have used two Measures for performance; Precision and Recall. These are two important measures to represent the efficiency of any Classification model. Table 1 shows neural network parameters & their respective accuracy while Figure 4 to 7 shows the Precision & Recall rate graphically for both Neural Network models.

Table 1: Neural Network Parameters

Neural Network	No. of Hidden Layers	No. of neurons in hidden layer	Training Function	Error Function	Layer 1 Transfer Function	Layer 2 Transfer Function	Recognition Accuracy
Feed Forward	01	22	Trainlm	MSE	Tansig	Purelin	97.77
Pattern Net	01	26	Trainlm	MSE	Tansig	Tansig	95.55

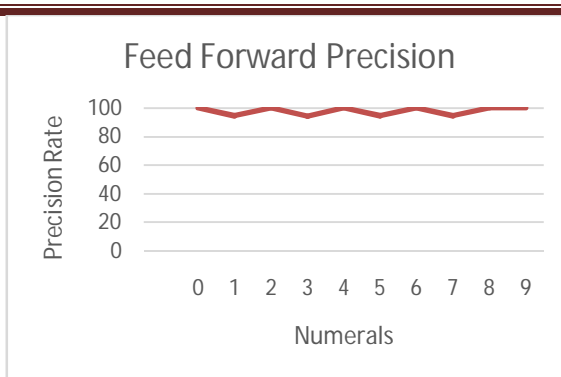

**Fig.4: Precision Rate for Feed Forward Neural Network**

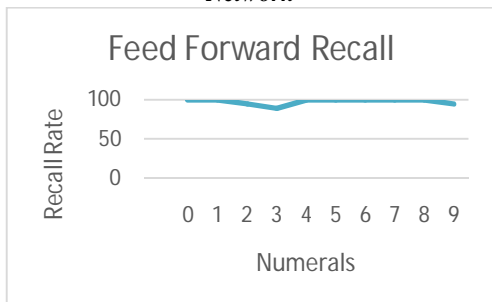

**Fig.5: Recall Rate for Feed Forward Neural Network**

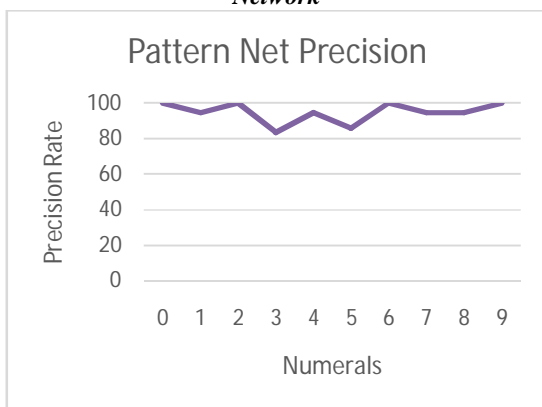

**Fig.6: Precision rate for Pattern Net Neural Network**

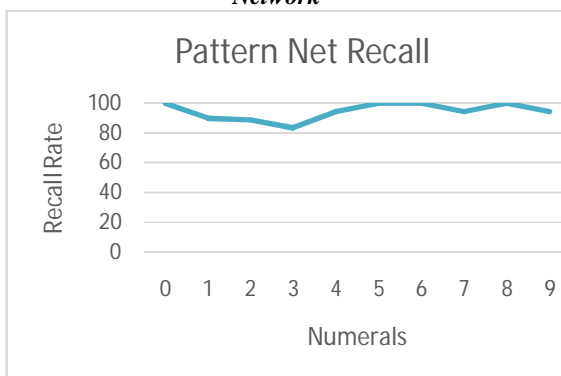

**Fig.7: Recall Rate for Pattern Net Neural Network**

## CONCLUSION

From Experimental Results; it can be concluded that Recognition Accuracy of any Neural Model depends upon Data on which it is trained; number and type of features the data that are given to the Neural Network. Therefore; performance of Neural Network model varies from problem to problem. For present problem we can say that; Feed forward Neural Network performed well than Pattern Net Neural Network.

## REFERENCES

- [1] Nidal F. Shilbayeh, Remah W. Al-Khatib, Sameer A. Nooh "Segmentation of Arabic Handwritten Numeral Strings Based on Watershed Approach" Volume 13 No 09, 2019
- [2] Saleh Aly, Ahmed Mohamed "Unknown-Length Handwritten Numeral String Recognition Using Cascade of PCA-SVMNet Classifiers" IEEE Access Volume 07, 2019
- [3] Munish Kumar, M. K. Jindal, R. K. Sharma, Simpel Rani Jindal "Character and numeral recognition for non-Indic and Indic scripts: a survey" Artificial Intelligence Review Volume 52 Issue 4 December 2019
- [4] Ujjwal Bhattacharya, Member, IEEE B.B. Chaudhuri, Fellow, IEEE "Handwritten Numeral Databases of Indian Scripts and Multistage Recognition of Mixed Numerals" IEEE TRANSACTIONS ON PATTERN ANALYSIS AND MACHINE INTELLIGENCE, VOL. 31, NO. 3 MARCH 2009
- [5] Cheng-Lin Liu, Member, IEEE, Hiroshi Sako, Senior Member, IEEE, and Hiromichi Fujisawa, Fellow, IEEE "Discriminative Learning Quadratic Discriminant Function for Handwriting Recognition" IEEE TRANSACTIONS ON NEURAL NETWORKS, VOL. 15, NO. 2 MARCH 2004
- [6] PATIL S.B., SINHA G.R. "Off-Line Mixed Devanagari Numerals Recognition Using Artificial Neural Net-Work" Advances in Computational Research, Volume 4, Issue 1 2012
- [7] N. Das, R. Sarkar, S. Basu, M. Kundu, M. Nasipuri, and D. K. Basu, "A genetic algorithm based region sampling for selection of local features in handwritten digit recognition application" Applied Soft Computing, vol. 12, pp. 1592-1606, 2012.
- [8] N. Das, J. M. Reddy, R. Sarkar, S. Basu, M. Kundu, M. Nasipuri, and D. K. Basu, "A statistical-topological feature combination for recognition of handwritten numerals" Applied Soft Computing, vol. 12, pp. 2486-2495, 2012.
- [9] N. Das, K. Acharya, R. Sarkar, S. Basu, M. Kundu, and M. Nasipuri, "A Novel GA-SVM Based Multistage Approach for Recognition of Handwritten Bangla Compound Characters" Proceedings of the International Conference on Information Systems Design and Intelligent Applications 2012 (INDIA 2012) held in Visakhapatnam, India, January 2012." vol. 132, S. Satapathy, et al., Eds., ed: Springer Berlin / Heidelberg, 2012, pp. 145-152.
- [10] N. Das, S. Basu, R. Sarkar, M. Kundu, M. Nasipuri, and D. K. Basu, "Handwritten Bangla Compound character recognition: Potential challenges and probable solution" in 4th Indian International Conference on Artificial Intelligence, Bangalore, 2009, pp. 1901-1913.
- [11] N. Das, S. Basu, R. Sarkar, M. Kundu, M. Nasipuri, and D. K. Basu, "An Improved Feature Descriptor for Recognition of Handwritten Bangla Alphabet" in International conference on Signal and Image Processing, Mysore, India, 2009, pp. 451-454.
- [12] N. Das, K. Acharya, R. Sarkar, S. Basu, M. Kundu, and M. Nasipuri, "A Benchmark Data Base of Isolated Bangla Handwritten Compound Characters" IJDAR( Revised version communicated)

## Online Education: An Effective Way to Learn.

**Suresh J. Raut.** (MCA, MCM)

Post Graduate Teacher in Computer Science.

Reliance Foundation School, Nagothane. Dist:- Raigad, Maharashtra, India.

[sjraut11@gmail.com](mailto:sjraut11@gmail.com)

### ABSTRACT:

*In this pandemic situation (COVID-19), all are at home and using technology to meet, converse, message, chat, video call, etc. There is one important question that how to take education? How to go to school and colleges. The answer is "Online Education through Live Classes." Over the years, Education was restricted to the four walls of the classroom with a boring learning routine and sitting positions that are not ergonomic. Today, in this information technology world, all are using advanced computing devices having AI and Machine Learning Applications. Online live classes and examinations can be conducted using Cloud Applications.*

**Keywords:** Online Education, Dashboard, Collaboration, Covid-19, Pandemic.

### Introduction:

#### What is online learning?

Online learning is a teaching-learning platform that enables students to enrol and participate in live classes via the internet. It does not require being present in the physical classrooms. They can join from any location as long as they are connected to the internet. Not only that, online learning is an excellent way for subject matter professionals and experts to pass on their skills, aptitudes, and knowledge in an effective way.

#### Why online learning is more effective?

##### Following are the reasons:

**1. Enhances Skills:** Online learning is an effective means of updating our skills, knowledge, and attitudes. In a fast competitive world and this pandemic situation (Covid-19), you need to go ahead through a learning experience that is tailored to meet global education system. Teachers and students can use online learning to enhance their career progression and cultivate highly-demanded skills in the competitive world.

**2. Improve Your Productivity:** Learning equals earning. It is often said that you will need to learn first, then remove the 'L'. This is true at both the personal and institute / school levels. Individuals who invest in lifelong learning and training development will always see a significant improvement in their productivity. Various courses are available online to

assist you in achieving peak performance in your personal life and at work.

**3. Means of Communicating with Teachers and Educators:** The flexibility that online learning provides over traditional methods of education makes it possible to communicate with instructors. Technology simplifies these communication processes via live chat, email, as well as telephone conversations. You can also get feedback or engage in a Q&A session with a school teachers or a college professor. What an exciting way to network!

**4. Saves Time and Cost:** Online learning is budget-friendly. You can search for courses that align with your objectives and budget. The traditional costs of education are expensive. As long as you can log into your course dashboard when you want to, you can save some money to pursue other ambitions.

**5. Customize Your Learning Environment:** Online learning affords you the privilege of customizing your learning environment. You can learn while commuting, in your house, at a friend's house, or even set up your ideal classroom and complete your homework assignments.

**6. Enjoy a Flexible Schedule:** A significant benefit of learning online is flexibility. You have the privilege of engaging in some other rewarding activities. You can care for your family, work full-time, and earn a certification or degree. You can set academic goals on how many courses you want to take next year now. Planning will help you to incorporate your learning goals to align with other schedules better.

**7. Virtual Study Sessions:** Some virtual instructors call it 'contribution'. You can participate in virtual study sessions via discussion boards, assignments, seminars, chats, blogs, office hours, and the Q&A sessions. You can as well present documents, utilize whiteboards during brainstorming sessions and share your screen as long as you have a computer, an internet connection, and a headset. Learning online is now easier!

**8. Review Course Materials Easily:** You can access your course dashboard, which contains articles,

podcasts, videos, and written documents any time you want. Online learning makes it possible to scroll through the pages, utilize the find button, and take some online notes to understand the materials better.

**9. Learn as per Your Pace:** If you are missing the class session, online learning provides you recordings of missed classes. You can grasp each concept and theory as you have the opportunity to watch the class and learn without disturbing the teachers or educators. You determine your progress as you control your learning pathway.

**10. Develop Self-Discipline:** Online learning will force you to develop self-discipline skills such as time management and project management. You can make use of time management tools to schedule your time and activities using an online calendar. These lifelong skills will impact every aspect of your life.

**11. Evaluates Immediately:** Waiting to obtain your examination scores in a traditional setting is annoying and nerve-racking. The online learning framework provides an instant scoring mechanism that intimates you with your scores having completed the online tests and quizzes.

#### **COVID-19 Pandemic Situation for Education Field:**

In India, as precaution, in the second week of March, State Governments began shutting down schools and colleges temporarily and there was no certainty when they will reopen. This was a crucial time for the [education](#) sector—board examinations, nursery school admissions, entrance tests of various universities and competitive examinations, among others, are all held during this period. Due to no immediate solution to stop the outbreak of [Covid-19](#), school and university closures will have a long-term impact on the continuity of learning for more than 300 million young learners in India and also for economic and social consequences.

The system of schooling and learning, including teaching and assessment activities, was the first to be affected by these closures. Only some private schools could use online teaching methods. On the other hand, have completely shut down for not having access to [e-learning](#) resources and solutions. The students were missed opportunities for learning. Students are under the mental and social stress.

The impact of pandemic seen also on the higher education as well. A large number of Indian students enrolled in universities abroad, especially in countries very much affected by the pandemic, the US, UK, Australia and China. Many such students have now been decided to leaving these countries. If the situation continues in the long run, there may be a failure in the demand for international higher education.

A strategy is necessary to manage the difficulties in education sector and build the Indian education system in the long term. Following points may include while defining a strategy:

1. **Quick measures** are essential to ensure continuity of learning in government schools and

universities. Open-source digital learning solutions and Learning Management Software should be adopted so teachers can conduct teaching online. The Cloud Based Platform and applications are required to reach across all states in India, can be further strengthened to ensure accessibility of learning to the students.

2. **Inclusive learning** solutions, especially for the most essential and important need to be developed. With a rapid increase of mobile internet users in India, which is expected to reach 85% households by 2024, technology is enabling the access of educational activities even in the remotest parts of the country. This may be change the schooling system and increase the effectiveness of learning and teaching, giving students and teachers multiple options to choose from available online resources. Many districts have initiated innovative, mobile-based learning models for effective delivery of education, which could be adopted by others.

**Covid-19 Impact on Global Education:**

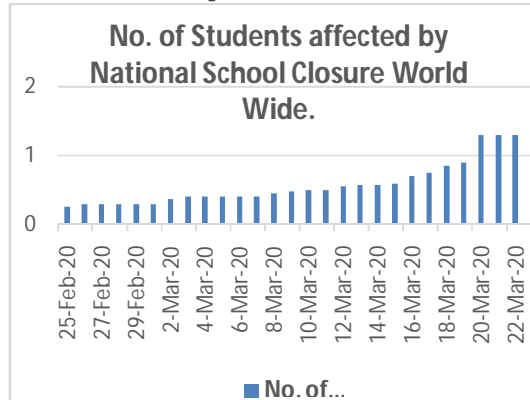

Figures refers to learners enrolled at Pre-Primary, Primary, Middle School, Secondary and Senior Secondary Education Levels.

3. It is also important to **review the current delivery and pedagogical methods** in school and higher education. Government should rebuild the education system which will be a seamlessly integrating classroom learning with e-learning modes. This is a major challenge to reforms at the national level. It is also important to establish quality assurance mechanisms and quality benchmark for online learning developed and offered by various e-learning platforms. Many e-learning portal offers multiple courses on the same subjects with different levels of certifications, methodology and assessment parameters. So, the quality of courses may differ across different e-learning platforms.

#### **Web Based Proposed Online Digital Learning System using Cloud Storage:**

In this time of crisis, a well-rounded and effective educational practice is what is needed for the capacity-building of young minds. It will develop skills that will drive their employability, productivity,

---

health, and well-being in the decades to come, and ensure the overall progress of India.

There may be a web based application using cloud storage having following features:

1. Effective Collaboration Platform
2. Effective Management of Online Classes
3. Attendance Reports
4. Structured Study and Practice Content.
5. Online Assignments and Homework Tracking facility.
6. Reporting of Class Conducted, Attendance and Assignment records to the Higher Authorities like Principal and Vice-Principal.
7. Accessible from Desktop/Laptop and Mobile.

**Online Digital Learning System (ODLS) may consist of following choices or menu options:**

1. Online Admission or Enrolments.
2. Daily Assembly Tool.
3. Online Live Class by subject, class and time table.
4. Online Homework or Assignment subject wise, class wise and date wise.
5. White board option for writing text or numbers.
6. Video and Audio publishing tools for teachers and students separately.
7. Various documents types posting tools for teachers and students separately.
8. Chatting tools.
9. Attendance tool.
10. Online Examination tool to conduct Pre, Mid and Post Mid Term examinations.
11. Online Assessment tool to check Answer Scripts and Assignments.
12. Digital Library and Virtual Laboratory.
13. Access to various application freely available in Open Source.

14. SMS Alerts for Students and Parents
15. Performance Analysis Report Generation.
16. Parent Teachers Meeting (PTM) using video conferencing tool.
17. Staff Meeting Tool.
18. Circulars publication tool for students and parents.
19. Annual Calendar Generation for Curricular, Co-Curricular and Sports activities.
20. Various in house competitions tools like Quiz, Debate, Drawing, Singing, etc.

**Conclusion:** In this current pandemic situation, we are having some online video conferencing applications like Zoom and Microsoft Teams which provides us to conduct online classes. But this is not a sufficient requirement for education system. Our education system must have a strong integrated web base application using cloud storage which could be accessible by enrolled students and school/college teachers. It must have all educational activities like learning and teaching, assignments and homework, intermediate and annual examinations, meeting and discussion, attendance and projects, virtual laboratory, digital library etc.

**References:**

1. Principal and Vice-Principal, Reliance Foundation School, Nagothane.
2. Teachers and Students from Government schools like Zilla Parishad and Municipal Corporation's Primary/Secondary Schools.
3. Data statistics from UNESCO web site <https://en.unesco.org>.
4. Website : <https://www.weforum.org/agenda/2020/04/coronavirus-education-global-covid19-online-digital-learning/>
1. Web site : <https://education.microsoft.com/en-us>

## Virtual data modifications using linear or nonlinear mathematical Algorithm to enlarge available information of covid 19 with hypersphere, euclidean

**Vishal Joshi**

Research Scholar, Department of Computer Science  
and Application Sri. Satya Sai University of Technology  
and Medical Sciences Sehore, M.P, India, 466001

[joshivishal18@gmail.com](mailto:joshivishal18@gmail.com)

**Jitendra Sheetlani**

Department of Computer Science and Application  
Sri. Satya Sai University of Technology  
and Medical Sciences Sehore, M.P, India, 466001

[dr.jsheetlani@gmail.com](mailto:dr.jsheetlani@gmail.com)

### ABSTRACT:

Distance measures for some time especially with regard to covid 19 data comparison methodologies, I thought it's time to provide a brief mathematical approach to make big data from available small size data. Companies, governments from world are gathering the location data of millions of internet and mobile phone, by considering different attributes users for clues about how the virus spreads or what and how much effect of social distancing measures are working. Unlike surveillance measures that track the movements of particular individuals, these efforts analyze large data sets to uncover patterns in people's movements and behavior over the course of the pandemic. As human being there are lots of limitations also lack of knowledge, parameters resources.

The current covid 19 raises important questions about opening, sharing and using data, and highlights the challenges associated with data use. To address the ongoing need for data-driven decision making, Open Data which is smaller and may inconsistent and inconvenience found, organized by the stages of the data value chain: availability, openness, dissemination, and use and uptake. And mathematical approach may enlarge covid data for future use.

I thought it time I explained the logic of this, and why I feel some of the coefficients used within some popular statistical programs are sometimes less than optimal. The recent feature extraction process for small data works on increase scale the performance. How to modify a cybernated virtual sample set with good correlation and specifications based on the original set of data is one of the challenge. In our process we are using Euclidean distance terminology in hypersphere. Actually consider set of covid 19 input data to extract that attributes so that resultant set of patients covid attributes should be expanded.

*Key Words: Euclidean distance; cybernated , virtual specimen; Small data; feature extraction, non linear*

### 1. INTRODUCTION

To generate virtual sample in covid 19 data linear mathematical equation are used recently but If we

implement by non linear way which may generates good virtual samples using

Chain discovery method. The proposed method, finds the minimum Euclidean distance.

The proposed method will help to create cybernated data for covid 19 mining which further better use of available resources. In the covid 19 sector, only restricted knowledge can be obtained. Only little coaching dataset is on the market for analysis purpose. So the data derived is naturally not stable enough to effectively create predictions. A small coaching dataset unfortunately ends up in low learning accuracy with regard to classification of machine learning, and the data derived is often fragile, and this is often called the tiny Specimen problem.

In the big data, though, machine learning algorithms works a wide range of covid 19 applications, and sufficient sample size and sample distribution of uniformity are always key factors in determining the predictive model accuracy and robustness. Moreover, adequate training samples provide an important guarantee for improving the generalization ability of traditional supervised learning. Due to high acquisition cost or incapability of obtaining sufficient samples, insufficiently small sample sets bring about difficulty in prediction accuracy and robust conclusions as they are always imbalanced and deteriorate

the data circumstances. Therefore, the covid characteristics cannot be fully reflected. The small sample machine learning problem, in which the number of observations is usually less. Actually if we talk about covid data is very large in practical applications. The main goal of this paper is to develop a mathematical model well adapted to covid 19 taking into account the special characteristics mentioned previously. The model should be able to estimate, considering different scenarios, the number of cases, deaths and needs of beds in hospitals, in territories where covid 19 is a very serious health problem. It

---

needs to be complex enough to capture the most important effects, but also simple enough to allow an affordable identification of its parameters, using the data that authorities report on this pandemic.

## 2. RELATED WORK

### 2.1 Classifiers:

classifiers, a clustering algorithm, and an association rule learner. The software architecture is flexible enough to permit other learning schemes, and other types of learning schemes. We could have also considered sub-compartments organized by ages, etc., but that would complexify the model and would hinder the identification of parameters. For instance, we could use in each compartment a different natality rate for the people infected according to their age distribution. Actually, since the natality and mortality do not seem to be important factors for covid 19

### 2.2 Meta-Classifiers

In computational learning theory have led to methods that enhance the performance or extend the capabilities of these basic learning schemes. We call these performance enhancers “meta-learning schemes” or “meta-classifiers” because they operate on the output of other learners. Instead of using a single classifier to make predictions, why not arrange a committee of classifiers to vote on the classification an instance? This is the basic idea behind combining multiple models to form an ensemble or meta classifier.

### 2.3 Clustering

Clustering methods do not generate predictive rules for a particular class, but rather try to find the natural groupings in the dataset. This technique is most often used in an exploratory fashion, to generate hypotheses about the relationships between data instances. Clustering is often followed by a second learning stage, in which a classifier is used to induce a rule set or decision tree that allocates each instance in the dataset to the cluster assigned to it by the clustering algorithm. These classifier-generated ‘cluster descriptions’ can then be examined to gain a semantic understanding of the clusters for covid data.

### 2.4 Neural Network Classifier:

Neural networks have emerged as an important tool for classification of covid 19 parameters. The recent vast research activities in neural classification have established that neural networks are a promising alternative to various conventional classification methods. The advantage of neural networks lies in the following theoretical aspects. First, neural networks are data driven self-adaptive methods in that they can adjust themselves to the data without any explicit specification of functional or distributional form for the underlying model. Second, they are universal functional approximators in that neural networks can approximate any function with arbitrary accuracy. Neural networks are nonlinear model-free method.

That the outputs of neural networks are least square estimates of the Bayesian a posteriori probabilities

### 2.5 Characteristics of covid 19 :

According to the known characteristics of the covid 19 pandemic, we consider that each person is in one of the following symptoms.

**Susceptible** The person is not infected by the other.

**Exposed** The person is in the incubation period after being infected by the disease pathogen, and has no visible clinical signs. The individual could infect other people but with a lower probability than people in the infectious compartments. After the incubation period, the person passes to the Infectious

**Infectious:** After the incubation period, it is the first compartment of the infectious period, where nobody is expected to be detected yet. The person has finished the incubation period, may infect other people and starts developing clinical signs. **Infectious but undetected :** After being in the compartment, the person can still infect other people, have clinical signs but is not be detected and reported by authorities. We assume that only people with low or medium symptoms can reach this compartment, not the people who will die

**Hospitalized or in quarantine at:** The person is in hospital or in quarantine at home can still infect other people.

**Hospitalized that will die:** The person is hospitalized and can still infect other people.

**Dead by covid 19 :** The person has not survived the disease. • **Recovered after being previously infectious :** The person was not previously detected as infectious, survived the disease, is no longer infectious and has developed a natural immunity to the virus.

**Isolation:** Infected people are isolated from contact with other people

**Quarantine:** Movement of people in the area of origin of an infected person is restricted and

**Tracing:** The objective of tracing is to identify potential infectious contacts which may have infected a person or spread covid 19 to other people. Increase the number of tests in order to increase the percentage of detected infected people.

## 3. LITERATURE SURVEY

Also study the behavior of the outputs shows when considering incomplete data due to number of reasons. By comparing those results with real observation data we can estimate the error produced by the model when identifying the parameters at early stages of the epidemic.

Finally, we see different scenarios to show how different values of the percentage of detected cases would have changed the impact of COVID-19 in China, which can be of interest for policy makers.

Here's the situation: we want to collect information over a covid 19 where data might get collected wrongly or insufficient, conditions in communications. In the real world, think even just

---

trying to have a conversation with lakhs of farmers manually about crop types, Soil types, fertilizers, water management, harvesting and lots of parameters are depend to check or taken in considerations . The idea is to find a way of communicating that will be robust to small changes in the data that is transmitted. Which will contradict to small size data problem If we collect Small size sample accurate data and enlarge using Hypersphere and Euclidean distance methodologies which will helps to improves system.

No doubt the application of machines and optimization of the big data has helped humanity thus far. Covid 19 is increasingly expanding its influence through AI and optimization of the big data. This development which led to the birth of the concepts, precision Covid 19 and smart farming inspired a paradigm shift in Agricultural practices and covid 19 business. It requires large knowledgebase for learning purpose.

#### 4. PROPOSED SYSTEM

##### 4.1 Chain rule

A central line of investigation in theoretical mathematics is identifying in each field of study a small set of basic ideas and rules from which all other interesting ideas and rules in that field can be logically expanded. Mathematicians and programmers, are particularly pleased when previously unrelated parts of mathematics are found to be derivable from one another, or from some more general theory. As mathematics has progressed, more and more relationships have been found between parts of it that have been developed separately—for example, between the symbolic representations of algebra and the spatial representations of geometry. These cross-connections enable insights to be developed into the various parts; together, they strengthen belief in the correctness and underlying unity of the whole structure.

To ensure that all the samples of a group in the range of the hypersphere should belong to an identical class, the purification process is executed. That is, for every group, we determine the center (center of gravity) and the maximum distance of the group as the radius of the hypersphere .

The results of theoretical and applied mathematics often influence each other. The discoveries of theoretical mathematicians frequently turn out sometimes decades later to have unanticipated practical value. Studies on the mathematical properties of random events, for example, led to knowledge that later made it possible to improve the design of experiments in the social and natural sciences. Theoretical mathematics, unlike the other sciences, is not constrained by the real world, but in the long run it contributes to a better understanding of that world.

We can apply such rule for covid 19 data for better knowledge.

##### 4.2 Mathematical Statements

Often a single round of mathematical reasoning does not produce satisfactory conclusions, and changes are tried in how the representation is made or in the operations themselves. Indeed, jumps are commonly made back and forth between steps, and there are no rules that determine how to proceed. The process typically proceeds in fits and starts, with many wrong turns and dead ends. This process continues until the results are good enough.

But what degree of accuracy is good enough? The answer depends on how the result will be used, on the consequences of error, and on the likely cost of modeling and computing a more accurate answer. For example, an error of 1 percent in calculating the amount of sugar in a cake recipe could be unimportant, whereas a similar degree of error in computing the trajectory for a space probe could be disastrous. The importance of the "good enough" question has led, however, to the development of mathematical processes for estimating how far off results might be and how much computation would be required to obtain the desired degree of accuracy.

Often a single round of mathematical reasoning does not produce satisfactory conclusions, and changes are tried in how the representation is made or in the operations themselves. Indeed, jumps are commonly made back and forth between steps, and there are no rules that determine how to proceed. The process typically proceeds in fits and starts, with many wrong turns and dead ends. This process continues until the results are good enough.

But what degree of accuracy is good enough? The answer depends on how the result will be used, on the consequences of error, and on the likely cost of modeling and computing a more accurate answer. For example, an error of 1 percent in calculating the amount of sugar in a cake recipe could be unimportant, whereas a similar degree of error in computing the trajectory for a space probe could be disastrous. The importance of the "good enough" question has led, however, to the development of mathematical processes for estimating how far off results might be and how much computation would be required to obtain the desired degree of accuracy.

##### 4.3 Raw Euclidean Distance

It is just a distance measure between a pair of samples from covid 19 domain  $p$  and  $q$  in an  $n$ -dimensional feature space in covid 19 data

$$\sqrt{\sum_{i=1}^n (q_i - p_i)^2}.$$

The Euclidean is often the "default" distance used in classification or clustering to find the closest points of a particular sample point. Another prominent example is hierarchical clustering, complete and single linkage where you want to find the distance



between clusters in covid 19 domain.

In terms of the Euclidean distance's use in machine learning, it could be used to measure the "similarity" between two vectors specifically for covid 19 domain (though you should normalize the data first). The farther away two vectors are, the

less similar.

## 5. CONCLUSIONS

As a theoretical discipline, mathematics explores the possible relationships attributes of covid 19 among abstractions without concern for whether those abstractions have counterparts in the real world. The abstractions can be anything from strings of numbers to geometric figures to sets of equations. mathematicians are interested only in finding a pattern or proving that there is none, but not in what use such knowledge might have. In deriving, for instance, an expression for the change in the surface area of any regular solid as its volume approaches zero, mathematicians have no interest in any correspondence between geometric solids and physical objects in the real world. Using Hypersphere and considering Euclidean distance we are trying to extract original dataset of covid 19 so that should not violate much more originality of features virtually and which can be used for further research to make or generate good knowledgebase. Finally helpful for good expert system.

## REFERENCES

- [1] Chang, C.-C., & Lin, C.-J. (2001). LIBSVM: a library for support vector machines. [Online]. Available at: <<http://www.csie.ntu.edu.tw/~cjlin/libsvm>>.
- [2] Chen, L.-F., Mark Liao, H.-Y., Ko, M.-T., Lin, J.-C., & Yu, G.-J. (2000). A new LDA-based face recognition system which can solve the small sample size problem. *Pattern Recognition*, 33, 1713–1726.
- [3] Cortes, C., & Vapnik, V. (1995). Support-vector network. *Machine Learning*, 20, 273–297.
- [4] Dougherty, E. R. (2001). Small sample issues for microarray-based classification. *Comparative and Functional Genomics*, 2, 28–34.
- [5] Fukunaga, K. (1990). *Introduction to statistical pattern recognition*. Academic Press.
- [6] Huang, C.-F., & Moraga, C. (2004). A diffusion-neural-network for learning from small samples. *International Journal of Approximate Reasoning*, 35, 137–161.
- [7] Li, D.-C., Chen, L.-S., & Lin, Y.-S. (2003). Using functional virtual population as assistance to learn scheduling knowledge in dynamic manufacturing environments. *International Journal of Production Research*, 41, 4011–4024.
- [8] Li, D.-C., & Lin, Y.-S. (2006). Using virtual sample generation to build up management knowledge in the early manufacturing stages. *European Journal of Operational Research*, 175, 413–434.
- [9] Li, D.-C., Wu, C.-S., Tsai, T.-I., & Chang, F.-M. (2006). Using megafuzzification and data trend estimation in small data set learning for early FMS Scheduling knowledge.
- [10] Der-chiang Li and Chiao Wen Liu —Extending Attribute Information for Small Data Set Classification, □ *IEEE Transactions On Knowledge And Data Engineering*, Vol. 24, No. 3, March 2012
- [11] W.C. Li and C.W. Yeh, —A Non-Parametric Learning Algorithm for Small Manufacturing Data Sets, □ *Expert Systems with Applications* vol. 34, pp. 391-398, 2008.
- [12] D.C. Li, C.S. Wu, T.I. Tsai, and Y.S. Lina, —Using MegaTrend-Diffusion and Artificial Samples in Small Data Set Learning for Early Flexible Manufacturing System Scheduling Knowledge, □ *Computers and Operations Research*, vol. 34, pp. 966-982, 2007
- [13] Kanthida Kusonmano, Michael Netzer, Bernhard Pfeifer, Christian Baumgartner, Klaus R. Liedl, and Armin Graber, —Evaluation of the Impact of Dataset Characteristics for Classification Problems in Biological Applications, □ *World Academy of Science, Engineering and Technology* 34 2009
- [14] <https://www.ncbi.nlm.nih.gov/pmc/articles/PMC7190554/>
- [15] [http://www.let.rug.nl/~tiedeman/ml05/03\\_bayesian\\_hando ut.pdf](http://www.let.rug.nl/~tiedeman/ml05/03_bayesian_hando ut.pdf)
- [16] Guoqiang Peter Zhang —Neural Networks for Classification: A Survey, □ *IEEE Transactions on systems, man, and cybernetics—part c: applications and reviews*, vol. 30, no. 4, November 2000
- [17] Chongfu Huang, Claudio Moraga, —diffusion-neuralnetwork for learning from small samples, □ *International Journal of Approximate Reasoning* 35 (2004) 137–161
- [18] Yao San Lin, Der Chiang Li, —The Generalized Trend Diffusion modeling algorithm for small data sets in the early stages of manufacturing systems
- [19] Developing innovative applications in covid 19 using data mining Sally Jo Cunningham and Geoffrey Holmes
- [20] <http://www.pbarrett.net/techpapers/euclid.pdf>
- [21] <http://www.project2061.org/publications/sfaa/online/chap2.htm>
- [22] <https://blogs.scientificamerican.com/roots-of-unity/why-you-should-care-about-high-dimensional-sphere-packing/>
- 23 Tung-I Tsai, Der-Chiang Li , —Utilize bootstrap in small data set learning for pilot run modeling of manufacturing systems □ *Expert Systems with Applications* 35 (2008) 1293– 1300

## THE ROLE OF LEARNING ANALYTICS IN EDUCATION

VYANKAT MUUNDE<sup>#1</sup>,

Dr.BINOD KUMAR<sup>\*2</sup>,

Dr.SHAILAJA SHIRWAIKAR<sup>#3</sup>

<sup>1</sup>Research Scholar ,Department of  
Computer Science S.P.P.U. Pune  
Maharashtra ,india

<sup>1</sup>[mvv.parli@gmail.com](mailto:mvv.parli@gmail.com)

<sup>2</sup>Associate Professor ,JSPM, Rajarshi  
Shahu College of Engineering  
,Pune Maharashtra India.

<sup>2</sup>[binod.istar.1970@gmail.com](mailto:binod.istar.1970@gmail.com)

<sup>3</sup> Associate Professor(Retd.),Department  
of Computer Science S.P.P.U.Pune

Maharashtra ,india

<sup>3</sup>[scshirwaikar@gmail.com](mailto:scshirwaikar@gmail.com)

### ABSTRACT:

*The often quoted phrase "Data is the new fuel" is proving itself by influencing every field. Not even the area of teaching and learning is untouched. Nowadays every field is coming on the digital platform which means there is substantial rise in the generation and collection of data. As past data holds the key to the future, the practice of analysing data comes into existence to predict and prescribe the future. Applying data mining techniques to data in education, is an emerging interdisciplinary research field, also known as Educational Data Mining(EDM). The main objective of EDM is to understand the learning process, identify the indicators that measure learning outcomes and the parameters that define the learning environment. Considering the unique types of data found in educational environments, EDM is concerned with molding existing techniques and exploring new methods. The end goal is to improve the educational related decision process.*

*This paper summarizes data analytics process in the commercial world and explores the possibilities of similar techniques in the form of learning analytics and educational data mining, starting to be applied in education. The goal is to help education policymakers and administrators understand how data mining and analytics work and how they can be applied within online learning systems to support educational decision making.*

*This paper explores the research attempts in learning analytics and organize this knowledge to showcase role of learning analytics in education.*

**Keywords** — Learning analytics, Educational Data Mining (EDM),Academic Analytics (AA), Learning Management System(LMS)

### Introduction

In nation's progress, efficient education system plays an important role. The Learning analytics is area of research that extracts useful information from educational databases to understand students'

progress and performance. Learning Analytics is the Measurement, Collection, Analysis and reporting of information about learners and their contexts for the purposes of understanding and optimizing learning. The data collected from the teaching-learning process if increases, potential benefits of learning analytics can be far reaching to all stakeholders in education including students, teachers, leaders and policy makers. The learning analytics is tool to narrow the achievement gap, increase student success and improve the quality of education in the digital era. Some researcher all over world devoted for learning analytics development and its application

Rebecca Farguson, in his paper, focused on significant challenges for integrating the learning analytics parameters and proposed a reference model[20]. Philipp Leitner identified risk and six challenges regarding implementation of learning analytics and some other issued related with learning analytics which are useful for future research [19]. Yi Shan Tsail and others worked on project called SHEILA an acronym for Supporting Higher Education to Integrate Learning Analytics. This project used strategic planning and policy for learning analytics and also worked for systematic adoption of learning analytics in education institutes[21].

Philipp Leitner and Martin Ebner show that dashboard can help stakeholders monitor academic development by using data collection processing and presentation of data [18]. Nitin Patwa et al focused on learning analytics as an useful tool for maintaining and enhancing the quality of higher education[15]. Dai Griffiths, in his paper, suggested education process is like business where measurement of output is necessary and it can be measured by using learning analytics. He opined that both teachers and students are important for learning analytics and teacher must identify those students which need support and may suggest remedial action. The implementation of pedagogic practices deployed in education system, will increase the quality of education[7].

One of the significant trends in higher education is the overwhelming growth of educational data which has been used to advantage by EDM. It is concerned with developing and applying data mining methods to detect patterns in large amounts of educational data, and to better understand students and their learning environments [6,22]. Data mining methods supported by EDM are prediction, clustering, relationship mining apart from discovery with models and data retrieval for human judgment which are specific to the field of EDM.

### LEARNING ANALYTICS

The Learning Analytics process is made up of six distinct steps or components: Measurement, Collection, Storage, Analysis, Action, and Communication[2].

1. The Measurement involves deciding parameters that can be extracted from the learning process that convey the essence of the process. A learning event comprises of the three main components and data related to each component is important in defining the learning process.

■ Stakeholders in the learning process are people and data about each of them may be relevant

- Teacher – anyone engaged directly in facilitating learning: includes teaching assistants, associate lecturers, adjunct faculty, faculty, academic staff, and peers in some contexts such as MOOCs

- Manager – anyone responsible for the departmental-level and institutional-level management teachers and teaching activity

- Policymaker – anyone responsible for the setting of local, regional, national, or transnational level policies related to education.

■ Learning context is the context or environment in which the event occurs. In a way it describes the learning that has been already assumed and the one that is expected.

■ Learning instrument or knowledge element could be a lesson, test, experiment etc that is used to initiate the required learning process.

2. The Collection step typically involves capturing all the data related to a learning event. Every learner interaction will have related data about the learner as also the data about the knowledge element that is responsible for the learning process. The Collection becomes straight forward if the learner interaction is controlled by a learning management system. Most researchers have assumed the presence of a LMS and collection involves configuring LMS for capturing required data.

3. The storage of data should be carefully designed to provide appropriate unicode support.

The main features of educational data is that they are hierarchical. The most data in this environment is textual and categorical. In the Indian context the textual data will be in the local language.

4. The Analysis step involves applying data mining techniques to educational data and extract

useful patterns. Educational data mining can effectively use the three important data mining techniques

- Prediction:- It involves developing models that predict some aspects of data called response variables from some other aspects of data called predictor variables. Prediction models help in understanding and forecasting educational outcomes.

- Clustering:- It can be used split a dataset into categories. By creating cluster of learners with similar capabilities, the helpful learning process and the resources for the group can be recommended.

- Rules and Relationships- The process of extracting relationships between the data elements in the form of a set of rules can be used to relate student performance to learning sequences and can help in identifying useful learning strategies

Using these techniques, educational data mining researchers can build models to answer such questions as: [Marie Bienkowski et al 2012]

What sequence of topics is most effective for a specific group of students?

What student actions are indicators of enhanced learning (e.g., higher course grades)?

What student actions suggest satisfaction, engagement, learning progress, etc.?

What characterises an adequate learning environment ?

What will predict student success?

There is need to design a new set of analytical methods based on the requirements of the learning context

5. The outcomes of the analytic process should be actionable so that the learning process can be improved or modified to satisfy the learner's requirements. In a online learning management system the actions can be automated in the form of a feedback loop, but in the absence, the requisite decision support for the actions can be presented to the decision maker.

6. Since in most cases human intervention is inevitable, visually communicating the outcomes in the form of a dashboard is essential. There is need to design a visual dashboard that helps the decision makers in taking requisite decisions.

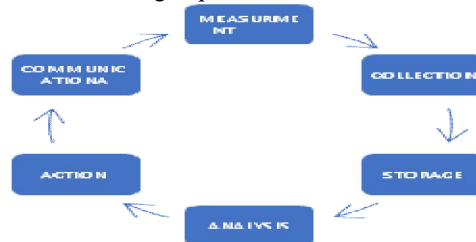

**Process of learning analytics and its components**

#### Key uses of learning analytics

The most common uses of learning analytics is prediction of student academic success, the identification of students who are at risk of failing a

---

course or dropping out of their studies. While it is reasonable that these two problems are far more powerful, the outcome from research and practice shows that there are far more productive and potential ways of using analytics for supporting teaching and learning.

The most popular goals of learning analytics include:

1. To support students for development of lifelong learning skills and strategies
2. The Provision of personalised and timely feedback to students regarding their learning
3. To support development of important skills such as collaboration, critical thinking, communication and creativity
4. Develop student awareness by supporting self-reflection
5. To Support quality learning and teaching by providing empirical evidence on the success of pedagogical innovations

#### **METHODOLOGIES FOR LEARNING ANALYTICS APPLICATION:-**

**Descriptive Analytics:** insight into the past

The aggregation and data mining to understand trends and evaluative metrics over time. The majority of statistics use falls into this category which is limited to past data and includes:

- The Student feedback gathered from student satisfaction and graduate surveys
- The analysis of data at all stages of the student lifecycle starting from admissions process , to student orientation, enrolments, pastoral care, study support, exams and graduations.

**Diagnostic Analytics:** why did it happen

This form of advanced analytics is characterised by techniques such as drill-down, data discovery, data mining and correlations to examine data or content to answer the question - "Why did it happen?" and includes:

- Analysis of data to inform and uplift key performance indicators across the organization
- Analysis of patterns to design appropriate metrics.
- The Learning management system metrics to improve student engagement with learning process.

**Predictive Analytics:** understanding the future

Combination of historical data to identify patterns in the data and applies statistical models and algorithms to capture relationships between various data sets to forecast

Some of the most popular goal of learning analytics include:

1. To support student development of lifelong learning skills and strategies
2. The provision of personalised and timely feedback to students regarding their learning
3. The development of important skills such as collaboration, critical thinking, communication and creativity
4. To develop student awareness by supporting self-reflection

**Prescriptive Analytics:** advise on possible outcomes

Goes beyond descriptive and predictive by recommending one or more choices using a combination of machine learning, algorithms, business rules and computational modelling such as:

- Focusing on subject/courses where small changes could have a big impact on improving student engagement, feedback and outcomes
- Data visualisation via specific tools to provide program/degree level metrics on student enrolments, program stage, results and survey feedback to give teaching staff visual snapshots of students in their programs

#### **BENEFICIARIES OF LEARNING ANALYTICS:-**

The Learning Analytics provides researchers innovative and new tools to study teaching and learning. The data infrastructures improves from data capture and analysis, to visualization and recommendation, offering more timely, precise, actionable feedback. The educators, instructional designers and institutional leaders gain new insights once the learning process is persistent and visible.

These researchers do not specify where their data originates, but they do stipulate that their goal is to better understand students and the various learning environments. The core difference between the two fields is that learning analytics incorporates human judgment, while educational data mining relies on computer automation (Baker & Siemens, 2014; Pardo, 2014; Siemens & Baker, 2012). This difference is evident in the discovery analysis, and application of the data. For example, educational data mining researchers may apply their findings through having educational software automatically adapt to personalize learning experiences for users. The learning analytics results are used to inform instructors on how to assist struggling learners for their better development. (Baker & Siemens, 2014).

#### **BENEFITS AND GOALS OF EDM AND LA**

The benefits of Learning Analytics (LA) and Educational data mining EDM are explained further in many studies. The UNESCO policy brief explains the LA benefits in micro (individual user actions), meso (institution-wide), and macro (regional, national, or international) levels covering various stakeholders (Buckingham Shum, 2012). These stakeholders are considered in three main groups: educators, learners, and administrators.

The Learning Analytics and Educational Data Mining are valuable concerning the prediction of the future learning behaviour in order to provide feedbacks and adapt recommender systems based on learners' attitudes. The moreover, they are helpful to discover and enhance the learning domain models and to evaluate learning materials and courseware. They can advance the scientific knowledge about learners, detect their abnormal behaviour and problems, as well as improve the pedagogical support by learning software (Bienkowski et al., 2012; He, 2013). In fact, these two research areas are considered

---

complementary due to the holistic framework of LA and reductionistic viewpoint of EDM in gaining insights into learning processes (Papamitsiou and Economides, 2014).

### Conclusion

Education policy is for development of nation. Education system of any nation must be of good quality. Enhancing the quality of education involves number of stakeholders like teacher, student, parents, academic administration, school, college and educational policy makers. This paper concludes that EDM and LA play a vital role in maintaining and increasing the quality of education. This paper depicts that all over world there is quality research in this two areas of learning analytics and educational data mining and this is greatly benefitting the academic institutions

### REFERENCES

- [1] Baker, R. and Yacef, K. (2009). The state of educational data mining in 2009: A review and future visions. *Journal of Educational Data Mining*, 1(1):3–17.
- [2] Baker, R., & Siemens, G. (2012) Educational data mining and learning analytics. In Sawyer, K. (Ed.) *Cambridge Handbook of the Learning Sciences: 2nd Edition*, pp. 253-274. Retrieved from: <http://www.columbia.edu/~rsb2162/BakerSiemensHandbook2013.pdf>
- [3] Baker, R.S. and Inventado, P.S. (2014). Educational data mining and learning analytics. In *Learning Analytics: From Research to Practice*.
- [4] Bienkowski M, Feng M and Means B 2012 Enhancing teaching and learning through educational data mining and learning analytics: An issue brief Washington, DC SRI Int. 1–57
- [5] Borges, L. C., Marques, V. M., & Bernardino, J. (2013). Comparison of Data Mining Techniques and Tools for Data Classification. In *Proceedings of the International C\* Conference on Computer Science and Software Engineering* (pp. 113–116). New York, NY, USA: ACM. <https://doi.org/10.1145/2494444.2494451>
- [6] Cristóbal Romero and Sebastián Ventura. Educational data mining: A review of the state of the art. *Trans. Sys. Man Cyber Part C*, 40(6):601–618, November 2010.
- [7] Dai Griffiths, ( 2012), The Implications of Analytics for Teaching Practice in Higher Education
- [8] Greller, W., & Drachler, H. (2012). Translating learning into numbers: A generic framework for learning analytics. *Educational Technology and Society*, 15(3), 4257.
- [8] Hart, C. (2012). Factors associated with student persistence in an online program of study: A review of the literature. *Journal of Interactive Online Learning*, 11(1), 19-42.
- [9] Hofmann, E. (2012), Why dual enrollment? *New Directions for Higher Education*, 2012(158), 1–8. doi:10.1002/he.20009
- [10] IBM, *Managing the Business of Education* (white paper), 2009,

<http://www.techrepublic.com/whitepapers/managing-the-business-of-education-uniting-the-mission-of-education-with-the-mission-of-the-marketplace/1689899>. 2. Jing Luan, *Data Mining Applications in Higher Education*, SPSS Executive Report (DMHEWP-1004), 2004, [http://www.spss.ch/upload/1122641492\\_Data%20mining%20applications%20in%20higher%20education.pdf](http://www.spss.ch/upload/1122641492_Data%20mining%20applications%20in%20higher%20education.pdf).

- [11] Ihantola, P., Vihavainen, A., Ahadi, A., Butler, M., Börstler, J., Edwards, S. H., ... Toll, D. (2015). *Educational Data Mining and Learning Analytics in Programming: Literature Review and Case Studies*. In *Proceedings of the 2015 ITiCSE on Working Group Reports* (pp. 41–63). New York, NY, USA: ACM. <https://doi.org/10.1145/2858796.2858798>
- [12] Jayaprakash, S. M., Moody, E. W., Laura, E. J., Regan, J. R., & Baron, J. D. (2014). Early alert of academically at-risk students: An open source analytics initiative. *Journal of Learning Analytics*, 1(1), 6-47.
- [13] Juan-Claude Lemmens and Michael Henn , (2016), *Learning Analytics: A South African Higher Education Perspective* .
- [14] Jesús Rodríguez-Triana, Alejandra Martínez-Monés, Sara Villagrà-Sobriño, (2016), *Learning Analytics in Small-Scale Teacher-Led Innovations: Ethical and Data Privacy*.
- [15] Nitin Patwa, Seetharaman A, Sreekumar K and Srinivas Phani (2018) *Learning Analytics: Enhancing the Quality of Higher Education by in*
- [16] Oblinger, D. G. (2012). Let's talk analytics. *EDUCAUSE Review*, 47(4), 10-13.
- [17] Pardo, A. (2014). Designing learning analytics experiences. In J. A. Larusson & B. White (Eds.) *Learning analytics: From research to practice* (pp. 15-38). New York, NY: Springer.
- [18] Philipp Leitner, and Martin Ebner , (2017 ) *Development of a dashboard for Learning Analytics in Higher Education* .
- [19] Philipp Leitner, Markus Ebner, (2019), *LEARNING ANALYTICS CHALLENGES TO OVERCOME IN HIGHER EDUCATION INSTITUTIONS* .
- [20] Rebecca Ferguson ( 2014), *Learning analytics: drivers, developments and challenges*
- [21] Yi-Shan Tsai, Pedro Manuel Moreno-Marcos, Ioana Jivet, Maren Scheffel, Kairi Tammets, Kaire Kollom, Dragan Gašević (2018), *The SHEILA Framework: Informing Institutional Strategies and Policy Processes of Learning Analytics*.
- [22] [www.educationaldatamining.org](http://www.educationaldatamining.org).

## Impact of Fog Computing in Medical Service Delivery Sector

**Er. Sandeep Kumar Bothra<sup>1</sup>, Dr. Yogendar Kumar Verma<sup>2</sup>, Aleem Khan<sup>3</sup>**

<sup>1,2,3</sup>Assistant Professor, Department of Computer Application, S.S. Jain Subodh P.G. (Autonomous) College, Jaipur, (Raj.), India

<sup>1</sup>bothrajain@gmail.com ,

<sup>2</sup>yogyogi3733@gmail.com,

<sup>3</sup>aleem.khan@live.com

**ABSTRACT:**

*Fog computing is a buzzed word given by Cisco which explains that this technology bringing cloud computing closer to the end user. Various characteristics of fog like heterogeneity computing, high number of nodes, huge geographical distribution, mobility, low latency and location awareness, strong presence of streaming and real time applications extends the Cloud Computing paradigm to the edge of the network, thus enabling a new breed of applications and services under Fog computing.*

*Patient of critical diseases like cancer, heart attack, AIDS are face high expenditure on treatment due to visit at multiple hospitals for various routine checkup. A huge amount of data is not only collected, and stored but also processed and retrieved private data of patients in digital form. These problems are diminished by recent technologies like fog computing and Internet of Things by low investment in processing securely huge sensitive data of patient. Uninterrupted context-aware services to the end users as and when required both features enhance the popularity of these technologies. The aim of this paper is not only to discuss but also analyze various issues as well as available solutions in the medical service delivery sector under the fog computing environment.*

**Keyword:** Fog computing, Smart Things, Medical applications, Internet of things (IoT)

**1. Introduction of Fog Computing :**

Cisco recently delivered the vision of Fog computing to enable applications on billions of connected devices, already connected in the Internet of Things (IoT), to run directly at the network edge[3]. Customers can develop, manage and run software applications on Cisco IOx framework of networked devices, including hardened routers, switches and Internet protocol video cameras. Cisco IOx brings the open source Linux and Cisco IOS network operating system together in a single networked device (initially in routers). The open application environment encourages more developers to bring their own applications and connectivity interfaces at the

edge of the network. Regardless of Cisco's practices, We first answer the questions of what the Fog computing is, and what are the differences between Fog and Cloud.

In Fog computing, services can be hosted at end devices such as set-top-boxes or access points. The infrastructure of this new distributed computing allows applications to run as close as possible to sensed actionable and massive data, coming out of people, processes and thing. Such Fog computing concept, actually a Cloud computing close to the "ground", creates automated response that drives the value.

Both Cloud and Fog provide data, computation, storage and application services to end users. However, Fog can be distinguished from Cloud by its proximity to the end users, the dense geographical distribution and its support for mobility[4].

We adopt a simple three level hierarchy as In this framework (fig.1), each smart thing is attached to one of the Fog devices. Fog devices could be interconnected, and each of them is linked to the Cloud.

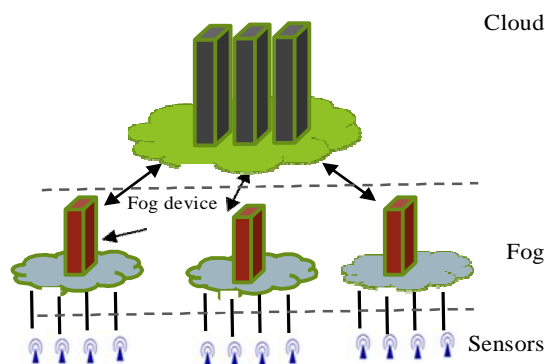

**Fig. 1.** Fog computing.

Three overviews of Fog computing paradigm have been published recently[5-7]. They provide comprehensive definition of Fog computing and comparisons to Cloud. To be distinguished, this overview takes a close look at the Fog computing paradigm by real application scenarios. This part of research is to investigate Fog computing advantages for services in several domains, such as Smart Grid, wireless sensor networks, IoT and software defined networks (SDNs). We examine the state of the art and disclose some general issues in Fog computing such as service migration among Fog devices and between Fog and Cloud.

Another unique contribution of this overview is to provide a comprehensive discussion on the security issues in Fog computing. Fog device is itself vulnerable to attacks, such as man-in-the-middle attack [8]. Therefore, We first analyse the system security issues according to current Fog computing paradigm. We provide experiments on the central processing unit (CPU) and memory consumption to investigate the stealthy features of the attacks. We further analyse the security issues among Fog devices and between Fog and Cloud. The authentication and authorization techniques will be discussed in this part of research. This paper is an extension of our previous paper [9] with more security issues.

## 2. Comparatively Study between Cloud Computing and Fog Computing :

Key features provide the main advantages of the fog computing contrary to the cloud computing approach. Table:1 shows the main differences between the fog and cloud computing and their impact in provisioning healthcare services. Due to the geographical distribution and the proximity closer to the end devices, fog can support user's mobility, location awareness, the reduction of latency, delay and jitter, elimination of data transmission in the network infrastructure, improvement of scalability, flexibility, and reassure the security of the encrypted data. However, fog has limited computational power, therefore, it cannot replace cloud computing. The integration and cooperation between them is necessary in order to enable big data analysis and support the creation, deployment, and execution of new healthcare services in order to provide personalized healthcare services oriented to users' needs and preferences based on their current health status[11].

Requirements	Fog computing	Cloud computing
<b>Mobility</b>	High	Limited
<b>Geographical distribution</b>	Distributed	Centralized
<b>Location of server</b>	At the edge of the network	Within the Internet
<b>Distance between the client and server</b>	In the physical proximity (one hop)	Faraway (multiple hops)
<b>Geographic coverage</b>	Wide	Global
<b>Location awareness</b>	Yes	No
<b>Latency</b>	Low	High
<b>Delay Jitter</b>	Low	High
<b>Bandwidth</b>	Low	High
<b>Response Time</b>	Seconds to minutes	Minutes, days, or weeks
<b>Hardware</b>	Limited storage /compute resources	Scalable storage/compute resources
<b>Data storage</b>	Temporary	Permanent
<b>Security</b>	Can be defined	Undefined
<b>Flexibility</b>	High	Limited
<b>Agility</b>	High	Limited
<b>Denial of Service (DoS) attack</b>	Low probability	High probability
<b>Type of last mile connectivity</b>	Wireless	Leased line

**Table: 1.** Cloud Computing v/s Fog Computing [12]

## 3. Benefits of Fog Computing in Medical Service Delivery Sector:

**Reduced Latency:** Compared to a device-to-cloud architecture, placing processing closer to the devices can reduce the latency since the physical distance is shorter and potential response time in a data center can be removed. Compared to a device-only architecture, latency can be reduced since computation-intensive tasks that take a long time on resource-constrained sensor devices can be moved to more capable fog computing nodes. The motivation can also be to keep the latency predictable [21].

**Privacy:** Compared to the device-to-cloud architecture, fog computing can reduce the propagation of data, for instance by analyzing sensitive data on a local gateway instead of a data center outside of the control of the user. This can improve the privacy of user data [22].

**Energy Efficiency:** There are several ways how fog computing can improve energy efficiency within sensor devices. First, gateways can serve as communication proxies, so that devices can increase the length of their sleep cycles. During the sleep mode, the gateway takes care of any requests or updates, which are then processed when the sensor device wakes up. Second, energy-intensive computations and other services can be offloaded from the battery-driven nodes [21].

---

**Bandwidth:** In comparison to a device-to-cloud architecture, fog computing can reduce the volume of data to be sent into data centers. This can happen in several ways: Raw data can be filtered, analyzed, pre-processed or compressed so that only a reduced amount of data needs to be forwarded [23], [24]. Local nodes can also answer requests from devices based on locally cached data, so that communication with data centers is not necessary at all [25].

**Scalability:** Fog computing can improve the scalability of a system. Local computation can reduce the load from more centralized resources, and be expanded as needed. Vaquero [22] refers to this as "mini-clouds."

**Dependability:** Fog computing can increase system dependability in two ways. It can be a means to realize redundancy, by letting several nodes in the network provide the same functionality. It can also execute computation closer to the sensor nodes, so that they are less dependent on the availability of a network connection to more centralized resources [20].

**Context:** In some cases, a fog computing node is the first node in a network that has enough overview to reason about a situation and the context of data. An example is a system that induces the current activity of medical staff from the location and activity of several devices [26].

#### **4. The Role of Fog Computing in Medical Service Delivery Sector:**

To make the environment eco and user friendly, Healthcare Industry needs to be prioritized with respect to service availability (as compared to the other Industries as mentioned above). Similar to other Industries (Mechanical, Electrical, or Civil), Healthcare Industry categorized from 1.0 to 4.0 generation. Healthcare Industry is still in its nascent stage as it marked its beginning in the year 1970. The efforts were preliminary and resources were limited, therefore, this stage was termed as Healthcare 1.0. Subsequent gain in the momentum of information technology (IT) field and medical technologies development of advanced medical imaging and tracking systems and the Healthcare 2.0. The advent of new and effective treatment methods has started with the intervention of computational methods and data processing systems. In this context, the period of 2006-2015, Healthcare 3.0, became popular due to use of electronic health records (EHR), an alternative version of patients data-chart. This generation has adopted the EHR to help doctors to get the relevant information on time[1].

Fog computing approach operates on network edge and acts as a bridge between the end-user devices and the cloud infrastructure of the healthcare provider. An architectural model is presented that shows how integration is achieved through the IoT, fog, and cloud technologies cooperation. The main component of the system model is the fog server that is a virtualized platform based on cloud computing approach with limited operations, deployed closer to the terminal equipment in order to enable protocol conversion, data storage, processing, and evaluation[2].

Nowadays, like other industries healthcare sector is also using online services. Data related to treatment are online transferred not only by doctors, patients, drugstores but also by Other users related to healthcare like insurance organizations[10]. This online facility is responsible for enhances the business related to healthcare services.

On the other side, Medicines that have produced side effects or unsuccessful to cure the complex disorders can be replaced by the pharmacist after the fabrication of the latest medicines.

If the information related to the invention of the latest medicines provided before further deaths than life can be saved which is most precious. Fortunately, data can be distributed throughout the world through Cloud Computing, without any geographical constraints. Healthcare organizations make the availability of information for Healthcare stakeholders across the world using Cloud Computing. It can be accessed from everywhere using the internet-enabled devices which offer efficient health information supervision, distributing and processing. So, Cloud Computing is cost-effective to access the information and services by users[10].

Furthermore, concerning the medical sector, it is better to select Cloud Computing to produce a common platform in IT spacing because various organization shares its resources to trim down the cost and enhance the usage. Based on Wu et al., By using cloud computing it is easy to take care of the patient through accessing the medical data at any time from anywhere in the world.

That's why several software companies and medical service providers are ready to move into Clouds rather than establishing and managing personal data centers. Cloud Computing is not only concentrating to access information from



anywhere in the world but also on improving the performance of EHRs supervision. For this, paper-based data must be converted into the electronic mode. Storing EHRs in the Cloud may lead to many issues of creating of adequate Healthcare monitoring system and maintaining EHRs securely in the Cloud.

If the security issues like privacy, access control, auditing, authentication, identity management, etc. are not addressed accurately then it will be difficult to use Cloud Computing technology in the medical sector.

### 5. Fog based Framework in Medical Service Delivery Sector :

Fog computing applications on health care have attracted most of the literature works. A wide variety of works about monitoring, detection, diagnosis and visualization of health maladies have been proposed in recent years. [15] and [16] discusses the characteristics of fog computing and services that fog computing can provide in the healthcare system and its prospect, in [14] Cao et al proposed FAST, a fog computing assisted distributed analytics system to monitor fall for stroke mitigation, they have implemented fall detection algorithms and incorporated them into fog-based distributed fall detection system, which distribute the analytics throughout the network by splitting the detection task between the edge devices (smart phones attached to the users) and the server (servers in the cloud), while In [17] Kyriazakos et al presented eWALL, an intelligent home environment offering personalized context-aware applications

based on advanced sensing and fog computing on the front and cloud solutions on the back.

In [18] Health Fog was presented, a framework where fog computing is used as an intermediary layer between the end users and the cloud. The design of Health Fog successfully reduces the extra communication cost that is usually high in similar systems. [19] fHealth is an open source framework proposed as a use case of fog oriented health care applications.

Framework name	Monitored disease	Used technique	Devices Software
FAST	Stroke (brain attack)	Fall detection	Smart phones, Cloud servers
eWALL	COPD, Mild Dementia,	Daily Activity Monitoring, Daily Functioning Monitoring	Sensors, Actuators, eWALL Cloud, Cloud Middleware
Health Fog	Multi purposes	Activity recognition, Cloud access security broker	Smart phones, Smart home devices, Wearable sensors
fHealth	Fitness	Activity tracking	Smart phones, Cloud servers

Table 2: Comparison between different fog based health care systems[13]

### 6. Conclusion and Future Direction

Significance fog computing is growing rapidly due to the fast development of computing services. This paradigm pushes more and more applications and services from cloud to the network edge which greatly reduces the data transfer time and the amount of network transmission. When moving towards the pay-as-you-go model, it allows paying only for what we use. It is a beneficial factor for the medical service sector by adopting the fog paradigm because there is no requirement to acquiring expensive IT infrastructure, maintenance, etc. as we know cloud computing providers take care of them. Life is priceless, and there are limited medical resources therefore, this emerging technology adopted by the medical service sector is a cost-effective concept where patients and the health sector take advantage of this new technology. However, Fog Computing adoption is slow due to a security issue in this Sector. The security issue can be caused by the lack of knowledge as to where the data is physically stored, what type of security mechanism is used to preserve the privacy of the data and whether these mechanisms are completely secure. For example, the patient who is facing issues like AIDS or any other social impact disease strongly rejects the kind of systems because they want a fully trusted Health Management System to store his sensitive information.

Finally, some challenges and open issues which are worth further study and research, including security and privacy, programming platform, energy consumption, are presented. Fog computing will serve as a more intelligent and greener computing model to promote the development of IoT and big data.

### 7. References

1. Aparna Kumari, Sudeep Tanwar, Sudhanshu Tyagi, Neeraj Kumar Fog computing for Healthcare 4.0 environment: Opportunities and challenges
2. Foteini Andriopoulou, Tasos Dagiuklas, and Theofanis Orphanoudakis, *Integrating IoT and Fog Computing for Healthcare Service Delivery*
3. Bonomi F. Connected vehicles, the internet of things, and Fog computing. The Eighth ACM International Workshop on Vehicular Inter-Networking (VANET), Las Vegas, USA, 2011; 13-15.
4. Bonomi F, Milito R, Zhu J, Addepalli S. Fog computing and its role in the internet of things.

- Proceedings of the First Edition of the MCC Workshop on Mobile Cloud Computing, MCC'12, ACM, Ambleside, United Kingdom, 2012; 13-16.
5. Vaquero LM, Rodero-Merino L. Finding your way in the fog: towards a comprehensive definition of fog computing. *ACM SIGCOMM Computer Communication Review* 2014; 44(5):27-32.
  6. Hajibaba M, Gorgin S. A review on modern distributed computing paradigms: Cloud computing, jungle computing and fog computing. *CIT. Journal of Computing and Information Technology* 2014; 22(2):69-84.
  7. Manreet K, Monika B. Fog computing providing data security: a review. *International Journal of Advanced Research in Computer Science and Software Engineering* 2014; 4(6):832-834.
  8. Zhang L, Jia W, Wen S, Yao D. A man-in-the-middle attack on 3G-WLAN interworking. *International Conference on Communications and Mobile Computing (CMC)*, Vol. 1, Zhangjiajie, China, April 2010; 121-125.
  9. Stojmenovic I, Wen S. The Fog computing paradigm: scenarios and security issues. *2014 Federated Conference on Computer Science and Information Systems (FeDCSIS)*: IEEE, Warsaw, Poland, 2014; 1-8.
  10. Wu, R., Ahn, G-J and Hu, H. Secure Sharing of Electronic Health Records in Clouds. *Proceedings of the 8th IEEE Int. Conf. on collaborative computing: Networking, applications and work sharing (CollaborateCom)*, Pittsburgh, Pennsylvania, USA, ACM. (2012). 711-718
  11. Integrating IoT and Fog Computing for Healthcare Service Delivery Foteini Andriopoulou, Tasos Dagiuklas, and Theofanis Orphanoudakis
  12. M. Firdhous, O. Ghazali, S. Hassan, Fog computing: will it be the future of cloud computing? in *Proceedings of the 3rd International Conference on Informatics & Applications*, Kuala Terengganu, pp. 8-15 (2014)
  13. Survey on Fog Computing: Architecture, Key Technologies, Applications and Open Issues Pengfei Hua, Sahraoui Dhelima, Huansheng Ning, **Tie Qiu**
  14. Y. Cao, S. Chen, P. Hou, D. Brown, Fast: A fog computing assisted distributed analytics system to monitor fall for stroke mitigation, in: *IEEE International Conference on Networking, Architecture and Storage*, 2015, pp. 2-11.
  15. V. Stantchev, A. Barnawi, S. Ghulam, J. Schubert, G. Tamm, Smart items, fog and cloud computing as enablers of servitization in healthcare, *Sensors & Transducers* 185 (2) (2015) 121-128.
  16. Y. Shi, G. Ding, H. Wang, H. E. Roman, The fog computing service for healthcare, in: *International Symposium on Future Information and Communication Technologies for Ubiquitous Healthcare*, 2015, pp. 70-74.
  17. S. Kyriazakos, M. Mihaylov, B. Anggorojati, A. Mihovska, R. Craciunescu, O. Fratu, R. Prasad, ewall: An intelligent caring home environment offering personalized context-aware applications based on advanced sensing, *Wireless Personal Communications* 87 (3) (2016) 1093-1111.
  18. M. Ahmad, M. B. Amin, S. Hussain, B. H. Kang, T. Cheong, S. Lee, Health fog: a novel framework for health and wellness applications, *Journal of Supercomputing* 72 (10) (2016) 3677-3695.
  19. Gasshopper, fhealth- a fog computing framework for activity tracking based climate control for smart living.
  20. M. Yannuzzi, R. Milito, R. Serral-Gracia, D. Montero, and M. Nemirovsky, Key ingredients in an IoT recipe: Fog Computing, Cloud computing, and more Fog Computing, in *19th International Workshop on Computer Aided Modeling and Design of Communication Links and Networks (CAMAD)*. IEEE, 2014, pp. 325-329.
  21. R. Deng, R. Lu, C. Lai, and T. H. Luan, Towards power consumption- delay tradeoff by workload allocation in cloud-fog computing, *IEEE International Conference on Communications (ICC)*, pp. 3909-3914, 2015.
  22. L. M. Vaquero and L. Rodero-Merino, Finding your Way in the Fog, *ACM SIGCOMM Computer Communication Review*, vol. 44, no. 5, pp. 27-32, 2014.
  23. Y. Cao, S. Chen, P. Hou, and D. Brown, FAST: A fog computing assisted distributed analytics system to monitor fall for stroke mitigation, *Networking*, pp. 2-11, 2015.
  24. K. Xu, Y. Li, and F. Ren, An energy-efficient compressive sensing framework incorporating online dictionary learning for long-term wireless health monitoring. *Institute of Electrical and Electronics Engineers Inc.*, 5 2016, vol. 2016-May, pp. 804-808.
  25. T. N. Gia, M. Jiang, A.-M. Rahmani, T. Westerlund, P. Liljeberg, and H. Tenhunen, Fog Computing in Healthcare Internet of Things - A Case Study on ECG Feature Extraction, *2015 IEEE Int. Conf. on Computer and Information Technology; Ubiquitous Computing and Communications; Dependable, Autonomic and Secure Computing; Pervasive Intelligence and Computing (CIT/IUCC/DASC/PICOM)*, pp. 356-363, 2015.
  26. M. Tentori and J. Favela, Activity-aware computing in mobile collaborative working environments, in *CRIWG'07: Proceedings of the 13th international conference on Groupware: design implementation, and use*. Berlin, Heidelberg: Springer-Verlag, Sep. 2007, pp. 337-353.

## IoT Applications Impact on Big Data: A Survey

**Girish B. Desale** \*<sup>1</sup>,

**Atul S. Patil** \*<sup>2</sup>

*Assistant Professor, Department of Computer Science & I.T.JET's Zulal Bhilajirao Patil College, Dhule Maharashtra, India.*  
<sup>1</sup>girishdesale@gmail.com , <sup>2</sup>atul\_patils@yahoo.com<sup>2</sup>

**ABSTRACT:**

*An evaluation of new innovations, Internet of Things (IoT) playing a vital role in smart home appliances, sensors, actuators, monitoring devices, healthcare, agriculture tools, transportation services and social media. As a result of this, the enormous usage of the web-technology and mobile applications are generating huge amount of multimedia data in various forms. In near future this will increase in multiplication through appliances for smart cities, healthcare, online transactions, smart energy grids etc. Ample research work is going on stockpiling, mining, acquisition and retrieval of data. In this survey paper we are discussing about Big data generated through IoT and its challenges as well as solutions through the Data Analytics. It also emphasis on fundamental challenges and future scenario in managing data generated through IoT.*

**Keywords:** *IoT, Big Data, Data Analytics.*

**I. Introduction**

**Internet of Things** (IoT) and Big Data are buzzing the technology world everywhere. Now days(IoT) is the backbone of ultramodern applications. **IoT** is an interconnected system of physical objects via the internet. The term ‘thing’ refers to real life objects, it can be a person or any device which is assigned through an IP address. This ‘thing’ accumulates and transmits data over the internet automatically. It helps them to communicate with the external environment or internal states to make the decisions [1]. The daily needs of the world is extensively using technology platforms which incorporate massive data such as videos, audios, images and text. The sources of such types of data are YouTube, Facebook, Instagram, Twitter, Flickr, iCloud etc. In addition to this IoT devices are raising this scenario by usage of sensor in the devices, actuators, home appliances, agree tools, transportation services and social media. **Such Big Data** involves a large set of structured, unstructured or semi-structured data and analysis of that data helps in business activities. This data is get captured, analyzed and processed, helps in decision making and increases revenues. In 2020, the digital data rate surpasses 40ZB. If we analyses this every individual is generating approx. 5000 GB of data. In this paper

we are discussing the new challenges towards data management, data analytics, data visualization, interoperability, data semantics, scalability, data fusion, data integration, data quality, and data discovery. Hence it is essential to understand the characteristics, challenges, and opportunities in concern with big data[2].

**II. IoT Related to Big Data**

The big data characteristics are massive volume, diverse Variety, and rapid velocity. The processing and analyzing of these data becomes difficult using the traditional data handling and analytic tools because the traditional datasets, which consist of text and number. Therefore, the multimedia big data requires more extensive and sophisticated solutions to handle the large volume of unstructured data. The major problem to analyze efficiently and effectively by big data analytics such as data handling, data mining, visualizing, and understanding the different datasets generated to handle real-time challenges. Studies lead by CISCO, and IBM states that 2.5 quintillions of data are generated each day[3].

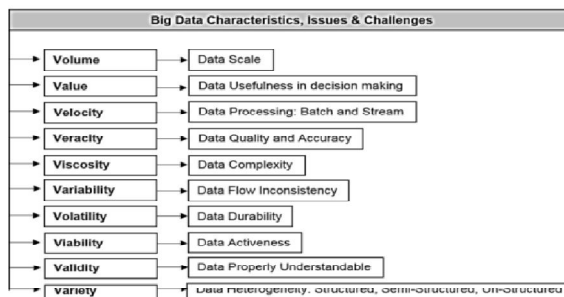

An IoT device generates non-stop streams of records and the researchers can broaden tools to extract meaningful data from these data the use of gadget learning strategies. Understanding these streams of records generated from IoT devices and analyzing them to get meaningful statistics is a challenging issue and it ends in massive statistics analytics. Machine gaining knowledge of algorithms and computational

intelligence strategies is the simplest solution to deal with large facts from IoT potential. [4]



IoT and Big Data

### III. Applications of IoT and Big Data

#### i. HealthCare

In Healthcare IoT, provides patient monitoring devices like smarty activity monitor, which is used for calculating the workout time, calories burned in workout, food and water intake, sleeping monitor, various services like mobile healthcare for medical wellness, prevention, diagnosis, treatment and monitoring services for the better treatment for the patients in a less cost.

#### ii. Industries

In Industries Internet of Things, smart machines are used than humans at accurately, capturing and communication data. It also saves time and money and support business intelligence efforts.

#### iii. Marketing

IoT have improved the market opportunities for equipment's manufacturing also develops economical growth of the business. IoT helps in the trading of the products and in financial exchange of the industries and the people. Money transfer is secured in the case of IoT.

#### iv. Transportation

In the case of IoT Transportation, provides various applications like smart parking by finding a parking space in a busy city centre, GPS tracking sensors and route maps. This helps in the monitoring of the vehicles by its geographical presents and its speed controls.

#### v. Smart Cities

IoT have made cities as smart cities with its applications like structural health, waste management, air quality management, noise management, traffic congestion, city energy consumption, smart parking, smart lighting, automation of public building and etc.

#### vi. Social Media

Social Internet of Thing is defined as an IoT where things are capable of establishing social relationships with other objects autonomously with respect to humans. The advantages of SIoT are shaping of network as required guaranteeing network navigations, hopeful in interactions among things (friends) and etc. [5]

### IV. The benefits of Big data and IoT

I. Observe the business trends.

- II. Searching hidden correlations.
- III. Outcome of new information.
- IV. ROI increase in the business.
- V. Improves the future e-health system.
- VI. Raising in self-service analysis.
- VII. Enhancing the transportation Industry.



Application Areas	Functions
Industry	Industrial environmental monitoring, energy saving, pollution control
Agriculture	Agriculture production, cultivation, monitoring, quality control
Logistics	Inventory control, e-commerce, e-logistics
Transportation	Intelligent traffic control, vehicle positioning and scheduling
Grid	Monitoring power station, scheduling, remote control
Home	Home security, distance learning, smart control of house-hold appliances
Safety	Hazards warnings in buildings, bridges, rail, water, food
Medical	Remote health monitoring, intelligent drug control

### V. IoT Impacts on BigData

Big Data and IoT have a huge impact on each other. The more the IoT grows it more it will place the demand on businesses regarding Big Data capabilities. It demands more advanced and innovative storage solutions. These continuously growing demands and workloads result in updating the infrastructure of an organization's Big data storage. Similarly, the IoT and Big Data combined applications accelerate the scope of research in both the fields. So, IoT and Big data both carry inter-dependency and need further development. Consistently, we make 2.5 quintillion bytes of facts; so much that 90% of the facts has been made over the last two years alone. Security and surety problems are widely spreading out by using velocity, volume, and mixture of enormous records. There are many deficiencies are present in both the technologies. And the most common is its security. Big data and IoT both require the concern about its security. [6]

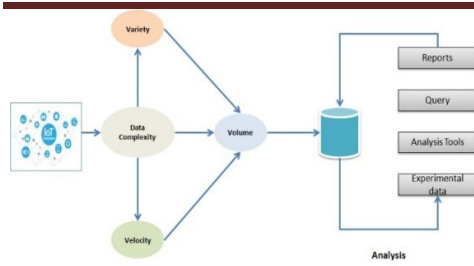

IOT Big Data Processing  
**VI. Challenging Issues to Data**

**i. Issues of Security for data**

The Internet of things has given new protection demanding situations that cannot be controlled by way of fusing conventional protection techniques. As Big data and IoT applications are accessing the use of cloud widely. In UK, big numbers of RFID cards have been deployed in many places but it failed due to lacking in security. Few security troubles are

- Secure filtering of redundant statistics
- Secure statistics facilities
- Secure transactions
- Access manage
- Imposing real time protection, and soon.

**ii. Storage for Big Data**

Lots of applications require a big storage, some data is real time value that automatically update it after few moments.

**iii. Analytics of Big Data**

Analytics is required to reveal secret patterns, unidentified correlations, and specific manufacturer document. [7]

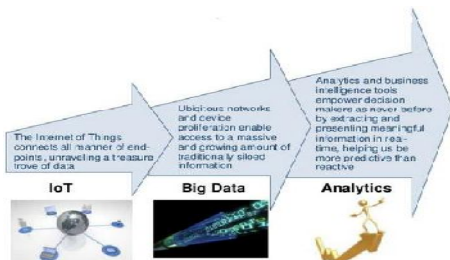

**IoT with Big Data Analytics**  
**VII. Methodologies and Techniques**

Lot of methodologies and techniques are available for improving the services of IoT and Big data.

**i. MapReduce:**

The Map Reduce structure collects all gadgets in formation and defines strategy for the best approach to fit. We need an arrangement of items and innovations made to control the difficulties of Big data.

**ii. Hadoop:**

parallelize records preparing through processing calculations. MapReduce helps it to handle enormous records set of various machines.

**iii. Pig:**

The Pig usage planned in the Hadoop structure to offer ad

ditional database as ability. A work area in Pig is a settled of tuples, and each issue is a rate or an arrangement of tuples.

**iv. HBase:**

HBase is a database show inside the Hadoop structure that resemble the first gadget of Big Table.

**v. Mahout:**

Mahout is particularly built on an Apache open-convey library which ready to be scaled and overseen for the huge amount of realities. The segments rely upon three full-estimate framework considering missions that Mahout as of now works.

- Collaborative separating
- Clustering
- Categorization/Classification.

**vi. NoSQL:**

This measurement is usually signified to as big records. Google, Facebook, Amazon and several uncommon organizations utilize NoSQL databases.

**vii. GFS:**

GFS is an assigned report gadget setup by methods for Google Inc. GFS is more suited for Google's most imperative realities stockpiling and use prerequisites which can create huge parts of insight that calls for reviewing. [8]

Layers	Architecture
Application layer	IoT applications
Knowledge processing layer	IoT tools
Data management layer	IoT middleware
Transport layer	IoT network
Physical sensing layer	IoT objects

Table: Big data IoT layered Architecture [9]

**VIII. Data Analytics Process**

**Streaming Analytics:** This form of data analytics is also referred as event stream processing and it analyzes huge in-motion data sets. Real-time data streams are analyzed in this process to detect urgent situations and immediate actions. IoT applications based on financial transactions, air fleet tracking, traffic analysis etc. can benefit from this method.

**Spatial Analytics:** This is the data analytics method that is used to analyze geographic patterns to determine the spatial relationship between the physical objects. Location-based IoT applications, such as smart parking can benefit from this data analytics.

**Time Series Analytics:** This type of data analytics is based upon the time-based data which is analyzed to reveal associated trends and patterns. Applications like weather forecasting and health monitoring systems can benefit from this data analytics method.

**Prescriptive Analysis:** This data analytics is the combination of descriptive and predictive analysis. [10]

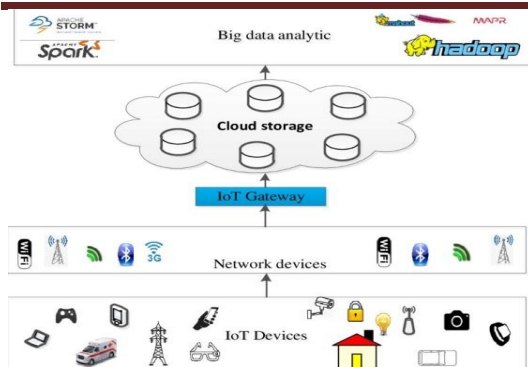

## XI. CONCLUSION

An IoT is used as an advanced technologies in various fields which communicates between devices with accuracy and also saves time and money. IoT have an infrastructure with various protocols. As it generates massive amount of real time data, we prefer big data techniques and data analytics to attempt the solution for this problems. But as the cloud plays a vital role in the IoT and Big Data with firewall for the security and privacy of data. This would be a really challenging task to work with real time data so as to access it from cloud with optimum speed. Again, the research efforts has to be carried out with data analytics process to make it more usable for solving complex problems.

## References

1. <https://techvidvan.com/tutorials/big-data-and-iot/>
2. [https://www.edureka.co/blog/big-data-applications-revolutionizing-various-domains/#Big\\_Data\\_in\\_IoT](https://www.edureka.co/blog/big-data-applications-revolutionizing-various-domains/#Big_Data_in_IoT)
3. <https://doi.org/10.1145/3206157.3206166>
4. <https://www.whizlabs.com/blog/iot-and-big-data/>
5. [https://www.researchgate.net/publication/\\_Internet\\_of\\_Things-An\\_Overview](https://www.researchgate.net/publication/_Internet_of_Things-An_Overview)
6. D. P. Acharjya, Kauser Ahmed P, "A Survey on Big Data Analytics: Challenges, Open Research Issues and Tools", International Journal of Advanced Computer Science and Applications, Vol. 7, No. 2, 2016.
7. <https://www.whizlabs.com/blog/iot-and-big-data/>
8. Tasleem Nizam and Syed Imtiaz Hassan, "Big Data: A Survey Paper on Big Data Innovation and its Technology," in International Journal of Advanced Research in Computer Science, Vol.8, No. 5, pp. 2173–2177, 2017.
9. World Scientific News 41 (2016) 1-315
10. [www.ijsrcsams.com](http://www.ijsrcsams.com) \Volume 8, Issue 1 (January 2019)
11. O.R. Team, Big data now: current perspectives from O'Reilly radar. O'Reilly Media (2011) Google Scholar
12. S. Hendrickson, Getting started with Hadoop with Amazon's Elastic MapReduce (2010), <https://www.slideshare.net/DrSkippy27/amazon-elastic-map-reduce-getting-started-with-hadoop>

## Performance Assessment of Classification Techniques using Weka Tool

**Mr. Anand J. Maheshwari,**

Assistant professor, R.C.Patel Arts, Commerce, and  
Science. College, Shirpur, K.B.C.N.M.U., Jalgaon, India,  
[a.j.maheshwari39@gmail.com](mailto:a.j.maheshwari39@gmail.com)

**Dr. G.R.Wani**

Associate professor, BASPONC College, Bhusawal,  
K.B.C.N.M.U., Jalgaon, India  
[gajuwani03@gmail.com](mailto:gajuwani03@gmail.com)

### ABSTRACT:

*In this research, a practical gain of classification procedures on as pine dataset that specifically categorizes a person has either normal or abnormal spine is executed based on certain physical features. Diverse approaches of machine learning in knowledge discovery were suggested depending on their characteristics, classification stands as one strategy that analyses a set of grouping rules which can be used to categorize future data and generalize data based on dissimilar instances. This paper explores four classifiers for performing evaluation and the goal stands for providing abroad exploration using Weka of these classifiers.*

**Keywords:** *evaluation, classification data mining, accuracy*

### I. Introduction:

Data mining is a method of mining useful, relevant data and patterns from big volumes of data. The data mining aims to retrieve valuable patterns from datasets and associate them into comprehensive construction for future access. Classification is a unique approach that can be relevant to mine models providing key data classes which aids us to gain a better understanding when data is large. Classification comprises dual stages; first, a classifier is advanced by stating encoded groups of information classes or perceptions. It is referred to as the learning phase where classifier constructs from training tuples from the database and their linked class labels. Since class label exists in this phase this step called supervised learning. Whereas in unsupervised learning, a class label of training tuple is not recognized and a group of classes to be educated is not known in advance. The truthfulness of the technique on the input test set is a portion of tuples that are exactly categorized by the classifier. [11]

The classifiers that we apply are, decision tree approach employs greedy approach in attribute selection and build a tree by applying divide and conquer method with attribute selection at each step based on various

measures provided by the algorithm. Naive Bayesian classifier that explores Bayes theorem of posterior probability. It presumes conditional independence between attributes. Multilayer neural network that executes the backpropagation algorithm to devise weights that can model data by exploring gradient descent strategy to reduce mean squared error between predicted and real class labels. The nearest neighbor that forecasts the class tag of strange data instances by taking the majority of the class label of k-nearest neighbor data occurrences.

In this proposed work we will consider these algorithms in Weka for parameters correctness exactness, precision and time.

### II. Research methodology

Classification stays on the easy progression of digging a task that explores appropriate concepts and classes of data for performing utilization of prototype to check the data objects for which class label is not known. In classification, a test set explored to develop a predictor but irrelevant test set is utilized to examine its accurateness. [1] The entire method of classification includes learning and classification. Assessment data is used to estimate the accuracy of classifiers in Classification Algorithms:

#### 1. Decision tree classifier:

A recursive divide conquer, top-down greedy method is the decision tree classifier. A tree-structured style in which intermediate nodes stay marked by attributes and outgoing edges denotes an output of test criteria on respective attribute and leaf nodes are noted for classes. In every leaf node, there will be one such class that will dominate and it is used as the label for that node. The algorithm usually starts with a root that represents all tuples in the training dataset. As we reach the leaf node during classification, a dominant class of leaf node is chosen for a new record to be classified. The data set is recursively partitioned into every node of the tree. The split into a partition is determined by the values of some attribute named as splitting attribute. Algorithm halts at the nodes that are pure that is all tuples in these nodes belong to the same class. Several criteria are devised to determine appropriate split to divide dataset. Famous

approaches are information gain, gain ratio, and Gini index used as attribute selection measure for splitting datasets. Decision trees can be represented by logical formulas.

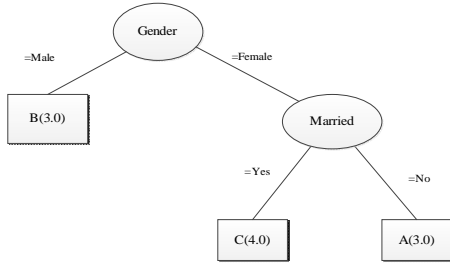

Fig.1: Decision tree classifier. [3]

**2. Naïve Bayesian classifier:**

This is a simple classifier that works well for various applications. We are given a record X to classify, a natural approach is to output that class  $C_i$  whose probability of occurrence is  $P(C_i | X)$  is maximum. To estimate the value of  $P(C_i | X)$ , the classifier assumes that attributes of X are independent of each other hence names as Naïve Bayes. Once we know this independence. The derivation to compute  $P(C_i | X)$  is as follows:

$$P(C_i | X) = P(X | C_i) P(C_i) / P(X) \quad (1)$$

$P(X | C_i)$  is to be maximized since  $P(C_i)$  is constant for all classes. A simplifying assumption is made when attributes are conditionally dependent.

$$P(X | C_i) = \prod_{k=1}^n P(x_k | C_i) = P(x_1 | C_i) \times P(x_2 | C_i) \times \dots \times P(x_n | C_i) \quad (2)$$

For continuous-valued attribute we use a Gaussian distribution with mean  $\mu$  and standard deviation  $\sigma$ :

$$g(x, \mu, \sigma) = \frac{1}{\sqrt{2\pi}\sigma} e^{-\frac{(x-\mu)^2}{2\sigma^2}}$$

$$\text{and } P(x_k | C_i) = g(x_k, \mu_{ci}, \sigma_{ci}) \quad (3)$$

**3. Multi-layer Neural Network Classifier:**

A multi-layer feedforward neural network has three layers namely the input layer one or more hidden layer and an output layer. Each layer is consisting of input units, are continuously masked into the input layer. These inputs are transferred through the next layer named as the hidden layer. The result of one hidden layer can be input to another hidden layer and a group of hidden layers are random but normally one is being sufficient. The output of the last weighted hidden layer is input to an output layer that explores network prediction for inputted tuples.

**Perceptron:**

The easier type of the neural network is perceptron that has a single neuron having several real-valued binary inputs and outputs. The inputs are come via weighted edges and multiplied by weights on those edges. The overall input to neurons at any time is the sum of all weighted inputs. If net input exceeds a

threshold then neuron will be triggered and receives output as '1' otherwise '0'. [2]

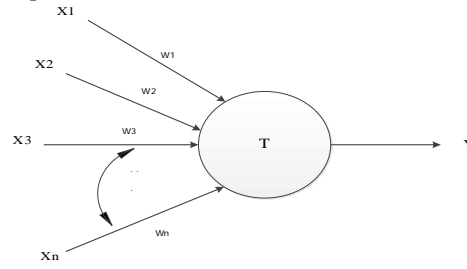

Fig.2: perceptron

If input is less than a threshold then the output is '0' else '1'. In situations when perceptron gives wrong answers weights should be decreased, determined by perceptron learning algorithm. The idea is that if the input through some edge is very high then that edge must be contributed to the error, hence it is reduced. In some other situations weight should be increased when net output is 1 but the desired threshold is low.

**4. K-Nearest Neighbor Classifier:**

This type of classifier is based on a comparison between the input test tuple with training tuples that are similar to it. Training tuples are named as n attributes. A tuple can be expressed as a point in n dimensional space. Entire training tuples are spaced on n-dimensional pattern space. When an unknown tuple is admitted k-nearest neighbor algorithm searches a pattern space for the k training tuples that are closest to unknown tuple. These k training tuples are the k 'nearest neighbors' of unknown tuples. Closeness is defined in terms of a distance metric, such as Euclidean distance:  $\text{dist}(X_1, X_2)$  [4]

For k-nearest neighbor classification, the unknown tuple is assigned the most common class among its k nearest neighbors. When k=1, the unknown tuple is assigned the class of training tuple that is close to it in pattern space.

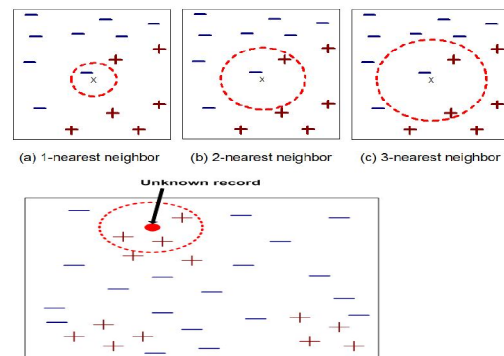

Fig.3: Nearest Neighbor Classifier.

**Statement of problem:**

In this paper we show assessment of classifiers to classify the show assessment of classifiers to classify a person whether he is normal or abnormal from collected data from the spine dataset. Data is



voluminous. The more we understand the data and context of data; we found patterns that are hiding and useful for classifying data. The major objective of this study is to classify a person based on the description of its physical characteristics.

### III .Data set for proposed work:

The data set we have taken is Column\_2C\_Weka.csv a public domain data set (CC0 1.0). This data set has seven attributes and total 310 instances are present (06 are numeric and 1 is categorical)

1. Pelvic\_incidence: Angle between a line perpendicular to a sacral plate and its midpoint and line joining the identical point. The choice of values is 26.1 to 130.
2. Pelvic\_tilt: it is the alignment of pelvic about the thigh- bones and rest of the body, the choice of values are -6.55 to 49.4 it can be tilt front, back or either side of the body [7]
3. Lumbor\_lordosis\_angle: Byexamining certain characteristics we need to understand between none, lower back problem, or walking ability. Ranges of values are 14 to 125.74
4. Sacral\_slope: defines an angle, higher the angle greater the likelihood, range of values are 13.36 to 121.43
5. Pelvic\_radius: It is measure from PR line to horizontal vertebral endpoint slopes. The range of values for this is 70 to 163.
6. Degree\_of\_spondylolisthesis: described according to its severity. The spondylolisthesis is categorized by calculating how much of a vertebral body has slipped forward over the body beneath it. The range of values for this is -11.0 to 418.54
7. Class: class label attribute is categorical attribute

### Preprocessing:

In data mining preprocessing is necessary to clean dirty data, so that random error, missing values can be removed this achieved by discretization of two attributes [10] as: Weka → filter → supervised → attribute → Pelvic\_incidence and Degree\_of\_spondylolisthesis. Scree shots of preprocessing in Weka are shown in fig.4.

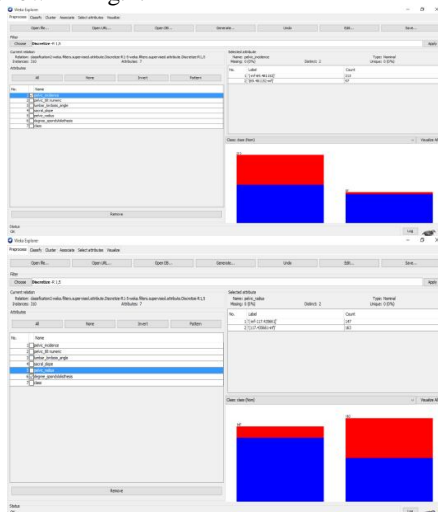

Fig4. Preprocessing using Weka Explorer.

## IV. Experimental observations and results:

The important motivation of this assessment needs to explore if possible to predict the performance of classifiers based on a particular data set. The classification model was developed using algorithms, various classification procedures and each one uses distinct classification methods. We explore the Weka Explorer application at this stage. Each classifier we apply for two types of analysis cross-validation and percentage split. [8]

### 1. Decision tree classifier:

In present evaluation we, use J48 classifier is used on data set and output of evaluation is shown in table:

Class	J-48 10 fold cross- validation		J48 % Split	
	TP-rate	Precision	TP-Rate	Precision
Abnormal	0.88	0.89	0.87	0.89
Normal	0.78	0.75	0.62	0.64
Weighted Avg.	0.84	0.85	0.82	0.83

Table#1: Decision tree classifier

With properly classified cases are 84.83 for cross-validation with mean absolute error =0.65 and 87.00 for percentage split, with mean absolute error 0.22 assessment from table deduce that true positive rate for an abnormal class is high than a normal class.

### 2. Bayesian classifiers:

In the present assessment, we explore two algorithms Bayesian and Bayesian network classifiers the assessments of these classifiers are shown in table#2 and table#3.

Class	Naïve Bayes 10 fold cross- validation		Naïve Bayes % Split	
	TP-rate	Precision	TP-Rate	Precision
Abnormal	0.74	0.92	0.69	0.94
Normal	0.62	0.48	0.88	0.48
Weighted Average	0.78	0.82	0.74	0.83

Table#2: Bayesian classifier

From table #2 Naïve Bayesian classifiers correctly classify instances up to 78% while 74% instances are classified based on % split. It also reveals the TP rate for class normal is high in % split (88%) than TP-rate of cross-validation (62%) but precision is the same.

From table#3 Bayesian network classifier correctly classify instances of 78% and 73 % of cross-validation and % split respectively. The TP rate for normal class is higher than abnormal class in both and most importantly precision is almost same.

Table#3 Bayesian network classifier

**3. Multilayer– perceptron classifier:**

In the present assessment of multilayer perceptron classifier properly classified instances are greater in cross-validation than % split the amount of time required to develop a model is slightly large in cross-validation also the TP-rate as shown in table#4.

Class	Multilayer Perceptron 10 fold cross-validation		Multilayer perceptron % Split	
	TP-rate	Precision	TP-Rate	Precision
Abnormal	0.88	0.89	0.84	0.91
Normal	0.78	0.75	0.76	0.62
Weighted Average	0.84	0.85	0.82	0.84

Table#4 Multilayer perceptron classifier

**4. K-nearest neighbor classifiers:**

Assessment is shown in table#5. In cross-validation, the correctness of the classifier is more than the % split of classifier also true positive-rate, also a precision of % split than in cross-validation.

Class	K-nearest neighbor 10 fold cross Validation		K-nearest neighbor % Split	
	TP-rate	Precision	TP-Rate	Precision
Abnormal	0.84	0.83	0.78	0.87
Normal	0.66	0.64	0.65	0.5
Weighted Average	0.77	0.77	0.75	0.78

Table# 5 k nearest neighbor classifier

Graphically the performance assessment is shown in fig.5

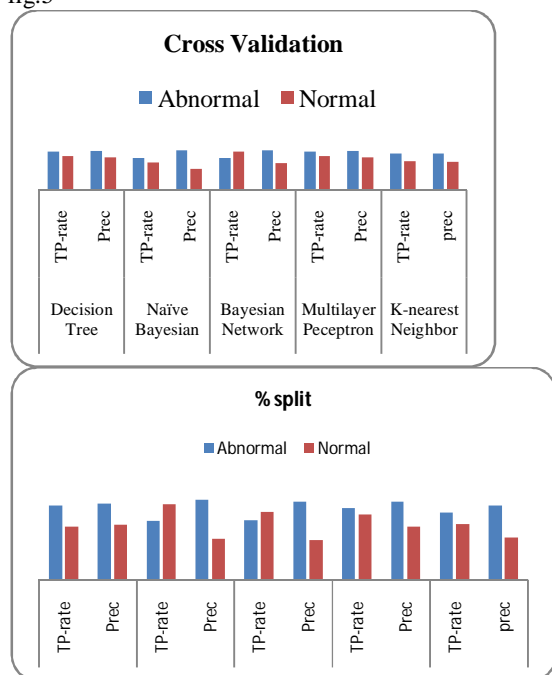

Fig.5 Classifiers performance assessment

**Conclusion:**

Class	Bayesian network 10 fold cross-validation		Bayesian network % Split	
	TP-rate	Precision	TP-Rate	Precision
Abnormal	0.73	0.91	0.7	0.91
Normal	0.88	0.61	0.8	0.47
Weighted Average	0.78	0.82	0.73	0.80

All assessment results of various classifiers we have used on the spine data set are based on attributes selected tells that the accuracy rate of classifiers is in the range of 70 % to 85% and each classifier behaves slightly differently on attributes in data set. The attributes that have a significant influence on classification are .pelvic\_incidence and degree\_ of spondylolisthesis. Decision tree classifiers are more suitable for concept learning. [5] Multilayer perceptron algorithm has more accurate than others but Bayes classifier has experimentally operational since the decision was taken by this algorithm is more correct even if probability estimates are inaccurate. The K-nearest neighbor classifiers are very vigorous to work with noise. In the future, we can try to emphasize on various knowledge mining techniques on more prolonged data sets having more and more dissimilar attributes so that elementary classifier algorithms can be extended.

**References:**

[1] Jiawei Han and Micheline Camber, Data Mining Concepts and Techniques, 2nd Ed., Morgan Kaufmann Publishers, Elsevier, Inc., 2006  
 [2] Vikram Pudi and P. Radha Krishna, Data Mining. Oxford university press, 5<sup>th</sup> impression 2012  
 [3] Arun K. Pujari, Data Mining Techniques, 3<sup>rd</sup> Ed, University Press (India) Limited, 2015.  
 [4] Archit Verma, Study and Evaluation of Classification Algorithms in Data Mining, IRJET, Vol: 5, Issue: 08, 2018  
 [5] C. Anuradha and T. Velumurgan, A comparative analysis of the evaluation of classification algorithm in the prediction of students performance, Indian Journal of Science and Technology, Vol 8(15), IPL057, 2015  
 [6] N. Chandra Sekhar Reddy, K. Sai Prasad and A Maunika, Classification algorithms on Data Mining: A study, Indian journal of computational intelligence research, Vol 13, Number 08, 2017  
 [7] [https://en.wikipedia.org/wiki/Pelvic\\_tilt](https://en.wikipedia.org/wiki/Pelvic_tilt)  
 [8] <https://medium.com/datadriveninvestor/k-fold-and-other-cross-validation-techniques-6c03a2563f1e>  
 [9] <https://www.mdpi.com/2073-4441/11/10/2076/html>  
 [10] <https://machinelearningmastery.com/how-to-handle-missing-values-in-machine-learning-data-with-weka/>  
 [11] <https://medium.com/datadriveninvestor/k-fold-and-other-cross-validation-techniques-6c03a2563f1e>

## THE ROLE OF INFORMATION TECHNOLOGY IN E-COMMERCE

**Mukesh Kumar**

(Assistant Professor, Department of BBA)  
Dronacharya College of Education, Rait Kangra (H.P.)  
E.mail : mukeshkumar86@gmail.com

### ABSTRACT:

*No matter the size of your enterprise, information technology has both tangible and intangible benefits that will help you make money and produce the results your customers demand. The pace of business change is getting faster. Information technology has the power to develop the industry and transform how business is run. Internet in business is used for information exchange, media promotion, electronic mail, mailing lists, dialogue, discussions, consulting with consumers online. The use of information technology through digital marketing is rising rapidly as they address the core pain points, or problems, of the business. There are two electronic commerce applications, namely: business-to-consumer and business-to-business commerce. Asia is primed for the transformative and disruptive impact of information technology. The main obstacle in the use of information technology is the enormous cost of making an online network or software, lack of communication protocol, stem security and supplying devices. The Smartphone market and Internet diffusion has proved to be a catalyst for growth of e-commerce industry. This paper aims to discuss the role of IT and its services in driving e-commerce industry in developing countries like India and the shift from e-commerce to m-commerce in the near future. The use of information technology plays an important role in business growth and to achieve target sales & for customer welfare.*

**Key Terms:** Information Technology, E-Commerce, Internet, Commerce, Economic growth

### I. INTRODUCTION

Electronic commerce, commonly known as E-commerce or e-commerce, is trading in products or services conducted via computer networks such as the Internet. Electronic commerce draws on technologies such as mobile commerce, electronic funds transfer, supply chain management, Internet marketing, online transaction processing, electronic data interchange (EDI), inventory management systems, and automated data collection systems. Modern electronic commerce

typically uses the World Wide Web at least at one point in the transaction's life-cycle, although it may encompass a wider range of technologies such as e-mail, mobile devices, social media, and telephones as well.

Electronic commerce is generally considered to be the sales aspect of e-business. It also consists of the exchange of data to facilitate the financing and payment aspects of business transactions. This is an effective and efficient way of communicating within an organization and one of the most effective and useful ways of conducting business. It is a Market entry strategy where the company may or may not have a physical presence. Information & technology plays an important role in the economic growth and development of e-commerce. It is a purposeful activity includes in planning, controlling, promotion and also distribution of various goods and services.

The concept of e-business is very flexible and therefore covers all possible uses of information and communication technologies. ICT infrastructure and services is not a major issue in developed countries but for developing countries like India it sometime seems to be a barrier in the growth of electronic commerce. e-commerce means sale or purchase of goods and services conducted over internet or TV channels. The goods are ordered electronically the payments or delivery of goods and services need not be conducted online. More usage of internet facilities, high educational standards, changing life style and economic growth of the country are the few major reasons for the demand of e-commerce techniques and tools. Among these techniques online shopping has a vital role. Among these reasons the growth of internet and its increased penetration into the rural areas of India is the most significant factor for the exponential growth of e-commerce and specifically online shopping. The budding breach of technology facilitators such as Internet connections, broadband and third generation services, laptops, smartphones, tablets and dongles, coupled with ever-increasing acceptance to the idea of virtual shopping, is set to steer the e-commerce industry. The growth of E-commerce enabled services are growing day by day globally and India progress is

extraordinary in this sector due to business's focuses on the use of ICT to facilitate the activities and associations of the business with customers. In India major players of E-commerce like Amazon India, Flipkart, Snapdeal, PayTm mall, Myntra, Jabong, Shopclue depend on extensive use of innovative IT tools to expand their market share and for enhancing sale. The further research areas in ecommerce are; the quality of sponsored ad text, ad position, Search Engine Optimization (SEO), PageRank, yellow pages, and bid management etc.

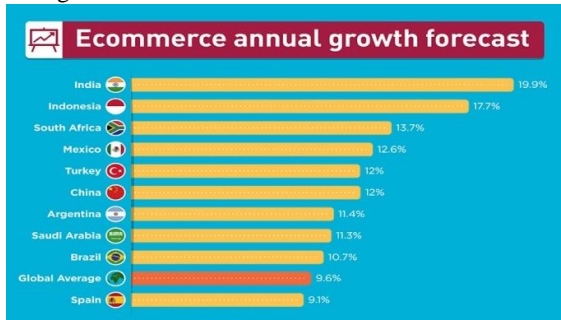

**Figure 1 : Global forecasted growth of E-commerce**

### 1.1 Types of E-Commerce

E-commerce conducted between businesses differs from that carried out between a business and its consumers.

There are five generally accepted types of e-commerce:

- Business to Business (B2B)
- Business to Consumer (B2C)
- Consumer to Business (C2B)
- Consumer to Consumer (C2C)
- Business to Government (B2G)

**A. Business to Business (B2B) :**Business to Business or B2B refers to e-commerce activities between businesses. An e-commerce company can be dealing with suppliers or distributors or agents. These transactions are usually carried out through Electronic Data Interchange or EDI. In general, B2Bs require higher security needs than B2Cs. For example, manufacturers and wholesalers are B2B companies.

With the help of B2B e-commerce, companies are able to improve the efficiency of several common business functions, including supplier management, inventory management and payment management. This e-commerce technology is also being used to improve the efficiency of managing payments between a business and its partners and distributors. By processing payments electronically, companies are able to lower the number of clerical errors and increase the speed of processing invoices, which results in lowered transaction fees.

**B. Business to Customer (B2C) :**Business to Customer or B2C refers to e-commerce activities that are focused on consumers rather than on businesses. For instance, a book retailer would be a B2C company such as Amazon.com and other companies that follow a merchant model or brokerage business models. Other examples could also be purchasing services from an insurance company, conducting online banking and employing travel services.

**C. Customer to Business (C2B) :** Customer to Business or C2B refers to e-commerce activities, which use reverse pricing models where the customer determines the prices of the product or services. In this case, the focus shifts from selling to buying. There is an increased emphasis on customer empowerment.

In this type of e-commerce, consumers get a choice of a wide variety of commodities and services, along with the opportunity to specify the range of prices they can afford or are willing to pay for a particular item, service or commodity. As a result, it reduces the bargaining time, increases the flexibility and creates ease at the point of sale for both the merchant and the consumer.

**D. Customer to Customer (C2C) :** Customer to Customer or C2C refers to e-commerce activities, which use an auction style model. This model consists of a person-to-person transaction that completely excludes businesses from the equation. Customers are also a part of the business and C2C enables customers to directly deal with each other. An example of this is peer auction giant, Ebay.

**E. Business to Government (B2G) :**It is a new trend in e-commerce. This type of e-commerce is used by the government departments to directly reach to the citizens by setting-up the websites. These websites have government policies, rules and regulations related to the respective departments. Any citizen may interact with these websites to know the various details. This helps the people to know the facts without going to the respective departments. This also saves time of the employees as well as the citizens. The concept of Smart City has been evolved from B2G e-commerce.

## II. REVIEW OF LITERATURE

E-commerce is the distribution, purchase, sale, marketing of goods and services through electronic systems such as the internet or television, www, or other computer networks. Ecommerce can involve electronic funds transfers, electronic data exchanges, automated inventory management systems, and automated data collection systems. The information technology industry sees e-commerce activities as the application and application of e-business (e-business) related to commercial transactions, such as: transfer of funds electronically, SCM (supply chain management), e-marketing (e-marketing), or online marketing (online marketing), online transaction processing, electronic data interchange (EDI), etc. E-commerce or e-commerce is part of e-business, where the scope of e-business is broader, not just commerce but also includes collaborating business partners, customer service, job vacancies etc. In addition to www network technology, ecommerce also requires database or database (e-mail) technology, e-mail, and other forms of non-computer technology such as the shipping system, and payment instruments for this e-commerce. The B2C segment seems to be most promising and is expected to lead the e-commerce market in the near future, in addition to the growth of ICT infrastructure the easy payment modes and innovative policies are some of the other factors behind this growth. In future, the sector is planning to offer much more revolutionary practices such as

---

transacting with the help of Mobile money, and having access to virtual trial rooms [Forrester Research, 2012]. e-commerce focuses on the use of ICT to facilitate the activities and associations of the business with customers. The further research areas in e-commerce are; the quality of sponsored ad text, ad position, Search Engine Optimization (SEO), PageRank, yellow pages, and bid management etc. [Gangeshwer, 2013]. Khosla (2017) Explains why E-commerce boom in India. Why online shopping in here to stay. The study conducted on the retail market in India suggests that the growing popularity of online shopping is affecting offline retailers since online companies are offering better prices and have attractive promotional strategies. It is also easy to reach the consumers online. The Online channel gives consumers the opportunity to shop anytime anywhere with the help of the internet this is the motivating the retail chains to get into the online business. UNCTAD E-commerce week (April 2019) emphasized the need to scale up support of information technology for a more effective contribution of E-commerce towards sustainable development.

### III. OBJECTIVES OF THE STUDY

1. To study the theoretical concept of E-Commerce.
2. To study the role of Information technology on E-Commerce.
3. To check new innovations in information technology assisting E-Commerce.
4. To explore the different innovative technologies shaping Indian E-Commerce sector.

### IV. RESEARCH METHODOLOGY

#### 4.1 Research Design

The research design for the present study was basically descriptive and exploratory in nature. The study started with exploratory research design in order to have a deeper insight of the E-commerce environment.

#### 4.2 Methods of Data Collection

For the said present research study is based on the secondary data. Such secondary data is collected from various reference books on E-Commerce, E-Business, Marketing Management, Marketing Research, Mobile Commerce, Internet Marketing, Electronic Advertising, Commerce, Management, etc. For the said research study the secondary data is also collected from the various National and International Research Books and Journals which are related to E-Commerce, Internet, Commerce, and Information Technology.

#### 4.3. Limitation of Research

The present study is largely exploratory in nature. Thus not withstanding its richness of data, it lacks control of variables (either through experimental design or through statistical techniques) influencing the research results. Time is a constant factor, so our expectations are not fully satisfied; there is a scope to improve it.

### V. The Benefits of Information Technology in E-Commerce:

Few innovations in human history encompass as many potential benefits as E-Commerce does. The global nature of the technology, low cost, opportunity to reach

hundreds of millions of people, interactive nature, variety of possibilities, and resourcefulness and growth of the supporting infrastructure (especially the web) result in many potential benefits to organizations, individuals, and society. These benefits are just starting to materialize, but they will increase significantly as E-Commerce expands. It is not surprising that some maintain that the E-Commerce revolution is just 'as profound as the change that came with the industrial revolution.

#### 5.1. Benefits to Organizations:

- Information Technology expands the market place to national and international market with minimal capital outlay, a company can easily and quickly locate more customers, the best suppliers, and the most suitable business partners worldwide.
- In Electronic commerce Information technology decreases the cost of creating, processing, distributing, storing, and retrieving paper-based information. For example, by introducing an electronic procurement system, companies can cut the purchasing administrative costs by as much as 85 percent.
- Ability for creating highly specialized businesses. For example, dog toys which can be purchased only in pet shops or department and discounts stores in the physical world are sold now in a specialized [www.dogtoys.com](http://www.dogtoys.com) (also see [www.cattoys.com](http://www.cattoys.com)).
- IT allows reduced inventories and overhead by facilitating "pull" type supply chain management. In a pull-type system the process starts from customer orders and uses just-in-time manufacturing
- In Electronic commerce IT initiates business processes reengineering projects. By changing processes, productivity of salespeople, knowledge workers, and administrators can increase by 100 percent or more.
- Electronic commerce lowers telecommunication cost the internet is much cheaper than value added networks.
- Other benefits include improved image, improved customer service, new found business partners, simplified processes, compressed cycle and delivery time, increased productivity, eliminating paper, expediting access to information, reduced transportation costs, and increased flexibility.

#### 5.2 Benefits to Consumers

- The benefits of Information Technology in E-Commerce to consumers are as follows:
- IT customers to shop or do other transactions 24 hours a day, all year round, from almost any location.
- Electronic commerce frequently provides customers with less expensive products and services by allowing them to shop in many places and conduct quick comparisons.
- In some cases, especially with digitized products, E-Commerce allows quick delivery.
- Customers can receive relevant and detailed information in seconds, rather than days or weeks.
- Electronic commerce makes it possible to participate at in virtual auctions.
- Information technology allow customers to interact

with other customers in electronic communities and exchange ideas as well as compare experiences.

**5.3 Benefits to Society:**

- With the help of IT tools Electronic commerce companies enables more individuals to work at home and to do less traveling for shopping, resulting in less traffic on the roads and lower air pollution.
- IT enabled Electronic commerce services enables people in third world countries and rural areas to enjoy products and services that otherwise are not available to them.
- Electronic commerce facilitates delivery of public services, such as health care, education, and distribution of government social services at a reduced cost and/or improved quality. Health care services, e.g., can reach patients in rural areas.

## VI. INNOVATIVE ROLE OF TECHNOLOGY IN E-COMMERCE

### 6.1 Electronic payment

Electronic payments are either debit or credit payments that are processed entirely electronically, with the value passing from one bank account to another bank account. Credit payments, often referred to as Electronic Credit Transfers (ECT) or Electronic Funds Transfers (EFT), are where a customer instructs their bank to make a payment, electronically, to another bank account. Debit payments, known as direct debits, are where a customer instructs their bank to allow the payment to be charged to their bank account. The modes of payment have surely changed in so many different ways. But it is important to take note that this change is on a positive note and not a negative one. In relation on how we get to make payments, the introduction of payment systems into the market has clearly made things a lot better. These systems are designed to make money transfer from one account to the other quick and easy as it can be done in a matter of seconds. The systems will come in two distinct features but for now we want to take a quick look at some of the different types of electronic payment systems. These are the kind of systems that will accept payments through electronic means:

India is among the top two countries globally on many key dimensions of digital adoption.

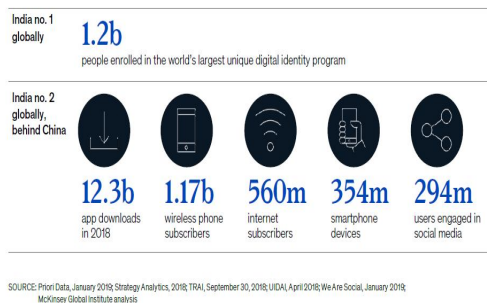

Figure 2 : Digital Adoption in India

### A. Electronic cards

Electronic cards are designed to reflect your bank account. By having one, it means that you definitely do

not need to visit your bank physically in order to access your account. Mostly cut out of hard plastic material to make them durable, the cards will have a magnet strip that allows the machines to be able to gain access to your bank account electronically. They will come in three major types. The debit card, the credit card and the prepaid card.

### B. Internet

This is a unique payment system that allows transactions to occur online. There are normally different sites through which you can be able to do this but the two most commonly practiced methods of online payments are direct transfers from one bank account to another or the use of cards.

### 3. Online accounts

This kind of payment system is slowly on the rise. We can attribute this to the increase of online shopping. Having an online account with either PayPal money bookers and or any provider allows you to be able to transfer funds more quickly as there are no restrictions and limitations on what you can do with your electronic money. One can be able to access their online accounts through their phones and or computers. These accounts are so simple to use.

### 6.2 The ICDT Business Strategy Model :

The ICDT model, developed by Albert Angehrn at INSEAD, is a systematic approach to the analysis and classification of business-related Internet strategies. It serves as a basis for identifying how existing goods and services can be extended and redesigned to take advantage of the Internet, as well as suggesting the characteristics of new goods and services made possible through this new medium. With the help of Information technology i.e. internet and support of ICDT model business can fully utilized its capacity to reach to its customers.

**6.3. Mobile Commerce: Mobile e-commerce (m-commerce) is a term that describes online sales transactions that use wireless electronic devices such as hand-held computers, mobile phones or laptops. These wireless devices interact with computer networks that have the ability to conduct online merchandise purchases. Any type of cash exchange is referred to as an e-commerce transaction. Mobile e-commerce is just one of the many subsets of electronic commerce.**

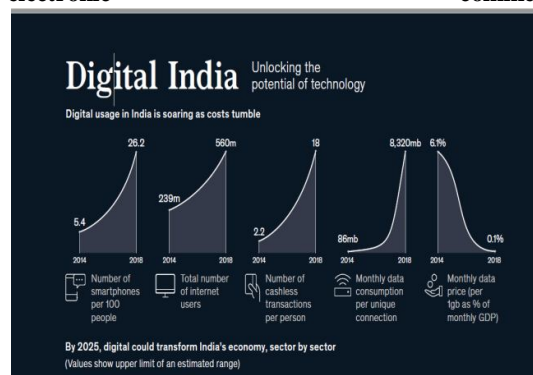

**Figure : 3 Usage of Information Technology :E Commerce**

**Source : Global Mckinsey Global Institutes analysis 2019**

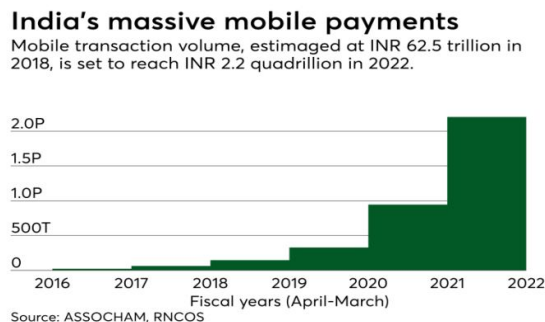

**Figure : 4 Mobile Payment trend in India**

**Source : Global Mckinsey Global Institutes analysis 2019**

#### 6.4 Other New IT channels in E – Commerce:

The following are the others emerging E commerce trend in which we can expect greater role of Information technology:

- Video marketing
- E. mail marketing
- Search & SEO Marketing.

#### VI. Technical Limitations of Information Technology in E-Commerce

- There is a lack of stem security, reliability, standards and communication protocols.
  - There is insufficient telecommunication bandwidth.
  - The software e development tools are still evolving and changing rapidly.
  - It is difficult to integrate the Internet and E-Commerce software with some existing applications and databases.
  - Vendors may need special Web servers and other infrastructures in addition to the network servers.
  - Some E-Commerce software might not fit with some hardware or may be incompatible with some operating systems or other components.
- But we can say that as time passes, these limitations will lessen or be overcome; appropriate planning can minimize their impact.

#### VII. CONCLUSION

The study concluded that the no sector will remain untouched by the Information technology revolution. The Indian E- Commerce Industry is considered one of the fastest growing industries in the world and technology has emerged as a helping hand to the industry. The world has seen a transition from being product-centric to being customer-centric – and retailers are leveraging technologies to reach the modern shoppers. The application of e-commerce technology is one of the important factors to support the success of a product from a company. To accelerate and increase sales quickly, by looking at

the rapid development of information technology, we can utilize an on-line service in the form of e-commerce. So far, the sales system of customers used by companies is only in writing and manual, which often tends to be misleading. With the existence of e-commerce services that can be quickly enjoyed by customers and companies themselves, all services desired by customers can be immediately followed up as quickly as possible, so that the company will be able to provide the best and fastest service for customers. E-commerce, is the use of communication networks and computers to carry out business processes. Mostly e-commerce, occurs between businesses, and not between business and consumers. The development of the use of technology through electronic networks in daily life has covered various aspects, including trade activities. Since ancient times humans have been familiar with cross-country trading activities, which are carried out by exploring continents around the world with simple vehicles or transportation. Technology development very helpful to humans and make human life easier.

#### REFEENCE

Vetri Selviv (2018) Impact of ICT in E- commerce Volume 5 (Issue-3) Page (110-112)  
 Vinod Kumar, Arif, Majid Malik, (RIAT-2014) Role of ICT in driving E commerce business in developing countries (Nov 26-27) 2014  
 Alex Koster, Bahjat El-Darwiche, Karim Sabbagh, Milind Singh, Roman Friedrich(2015) Digitization for Economic Growth and Job Creation: Regional and Industry Perspectives.  
 Payel Chaudry(2015) Role of Digitization and E-commerce in Indian Economic Growth: An Employment Generation Perspective  
 European Commission (2006), A Review of the Impact of ICT on Learning, Luxembourg: Office for Official Publications of the European Communities, working paper  
 Jackson, M. and Sloane A. (2009), Organization Profiling and the Adoption of ICT: e-Commerce in the UK Construction Industry, Electronic Journal Information Systems Evaluation Volume 12 Issue 1 2009 (67-74)  
**Used Websites:**  
[http:// www. MGI-Digital-India-Report-April-2019.pdf](http://www.MGI-Digital-India-Report-April-2019.pdf)  
<http://www.digitalvidya.com/blog/growth-of-digital-marketing-industry-in-india>

## Review and Study of Big Data Analytics it's Life Cycles and Tools

**Dr. Bhojaraj H. Barhate**

Associate Professor in Computer Science  
Bhusawal arts, Science and P.O. Nahata Commerce College  
email- bhbrama123@gmail.com

### ABSTRACT:

*In the IT industry every type of data is used in huge scale form. There are lot of structured data transactions are made by industries as well as banks. Nowadays unstructured data generated from Facebook ,whatsapp, twitter etc like applications. Millions and Billions transactions processed on such unstructured data. Every data new and innovative tools are used for cleansing and classifying such data.*

**Keywords:** MongoDB, Tablau, Hive, Apache Spark etc.

### Introduction

Big data refers to large volumes of data that cannot be effectively processed with traditional existing non-applications. The processing of big data begins with raw data that is not aggregated and is often impossible to store in a single computer's memory. A buzzword term used to describe vast volumes of data, both structured and non-structured, Big Data occupies day-to-day business. Big data is something that can go a long way in life Analyzing insights that can lead to better decisions and strategic business. Gartner's definition of Big Data is, "Big data is high-volume and high-speed or high-variety information assets that demand cost-effective, innovative types of information processing that enable enhanced insights, decision-making and processing.

### Data Analytics

Information analysis is the science of examining raw data to draw conclusions.

Data Analytics involves applying algorithms or mechanical processes to gain insights and, for example, working across multiple data sets to find meaningful correlations with each other.

It is used in many industries to allow organizations and companies to make better decisions as well as to

verify existing theories or models or. The focus of data analytics, Accordingly is the process of drawing conclusions based on what the researcher already entirely knows.

### Data Science

Dealing with structured and structured data, Data Science is a field that includes everything related to data cleaning, preparation and analysis. Data science is about statistics, mathematics, programming, problem solving, capturing data in creative ways, the ability to see things differently, and clearing, creating, and aligning data.

In simple terms, this is an umbrella of insights and techniques used to extract information from data.

### Applications of Data Science

#### 1. Internet search

Search engines use data science algorithms to give the best results for search queries in a fraction of a second.

#### 2. Advertising

Digital uses the entire digital marketing spectrum data science algorithm - from display banners to digital hoardings. This is the reason for getting more digital CTR than traditional advertisements.

#### 3. Recommender system

The structured system consulting system not only makes it easier to find related products from the millions of products but also makes it available. Many companies use this system to promote to the their products and suggestions according user's demand and the relevance of the information. The recommendations are based on the user's previous search results.

### Big data applications

#### i. Big Data for Financial Services



---

Big Data is used in credit card companies, retail banks, private wealth management consultant, insurance companies, venture funds and institutional investment in the financial services. This is how big data is used in many ways

1. Consumer Analytics
2. Compliance Analytics
3. Fraud Analytics
4. Operational Analytics

## ii. Big Data Communication

The main priorities for telecom service providers are to acquire new customers, retain customers and expand to the existing customer base. The solution to these challenges is the ability to combine and analyze customer-generated data and machine-generated data that is generated on a daily basis.

## iii. Data Retailing

Brick and Mortar or online e-teller, game and competitiveness is to better understand their service to customers. This requires the ability to analyze all web blogs, from various data sources that companies deal with on a daily basis transaction data, social media, and credit card data.

## Tools of Big Data Analytics

The growing demand and importance of data analytics in the market has led to many openings around the world. Top data analytics It is a bit difficult to shortlist data analytics tools because open source tools are going to be more popular, user friendly and perform better than the paid version.

### 1) R Programming

R is a leading analytics tool in the industry and is widely used for statistics and data modelling. It can easily handle your data and present it in different ways. SAS is surpassed in many ways such as data capacity, performance and results. R-UINX compiles and runs on a variety of platforms such as Windows and MacOS. It contains 11,556 packages and allows you to browse by package category. R also provides tools for automatically installing all packages according to user requirements, which can be well integrated with big data.

### 2) Tableau Public

Tableau Public is a free software that connects a corporate data warehouse, Microsoft Excel or web-based data to any data source and creates data visualizations, maps, dashboards, etc. with real-time updates on the web. They can be shared via social media or with clients. This allows access to download files in different formats. If you want to see a dramatic event happen suddenly, then we need to have a very good data source. The big data capabilities of Zoka have made them important and

one can analyze and visualize data better than other data visualization software in the market.

### 3) Python

Python is an object-oriented scripting language that is a free open source tool for reading, writing, and monitoring. It was developed in the late 1980s by Guido van Rossum that supports both functional and structured programming methods.

Just like JavaScript, Ruby and PHP, learning Python is easy. Also, Python has very good machine learning libraries. Cycleron, Thiano, Tensorflow and Keras. Another important feature of Python is that it can be integrated on any platform like SQL Server, MongoDB Database or JSON. Python can handle text data very well.

### 4) Apache Spark

Apache was developed in 2009 by the AMP Lab at the University of California, Berkeley. Apache Spark is a fast, large-scale data processing engine and runs applications 100 times faster in memory and 10 times faster on disk in the Hadoop cluster. Spark is built on data science and its concept makes data science easy. Spark is also popular for the development of data pipelines and machine learning models.

Spark also includes a library - MLlib, which includes sorting, regression, collaborative filtering, clustering, and more. Providing a progressive set of machine algorithms for similar iterative data science techniques

### 5) Excel

Excel is commonly used and very popular in industries. If you are an expert in Excel, R or Zanz, you will still need to use Excel. Excel becomes important when analyzing the client's internal data. It analyzes complex tasks including summarizing data with a preview of the main tables that help filter the data according to the client's needs. Excel has advanced business analytics options that help with modelling capabilities including prebuilt options including automatic relationship detection, DAX solutions generation and time grouping.

### 6) Apache Hadoop

Apache Hadoop is a clustered file system and a software framework used to handle big data. It processes large datasets of data through the Mapreduce programming model.

Hadoop is an open-source framework written in Java and provides cross-platform support.

No doubt, this is the biggest data tool. In fact, more than half of the Fortune 50 companies use Hadoop. Some of the big names include Amazon Web Services, HortonWorks, IBM, Intel, Microsoft, Facebook and more.

---

## 7) MongoDB

MongoDB is a document-based database in SQL, C, C++ and JavaScript. It is a free to use and open source tool that supports multiple operating systems including Windows Vista (and later versions), OS X (10.7 and later), Linux, Solaris and FreeBSD.

Key features include aggregation, ad-hoc queries, BSON format, sharding, indexing, replication, server-side execution of JavaScript, schemeless, capped collection, MongoDB Management Service (MMS), load balancing and file storage.

Some of the major customers using MongoDB are Facebook, eBay, MetLife, Google, etc.

## Life Cycle and Tools of Data

### Analytics

*A. Data Identification and Collection-* In this phase, different types of data sources are identified depending on the severity of the problem. Tools are needed to capture keywords, data and information from these heterogeneous data sources.

### Semantria , Opinion Crawl, OpenText, Trackur

*B. Data Storage-Unstructured* Captured Structured data must be stored in a database / data warehouse. NoSQL databases are required to accommodate big data. Organizations like Apache, Oracle, etc. have developed various frameworks and databases that allow analytics tools to retrieve and process data from these repositories.

Following are the NoSQL databases

### Apache HBase (Hadoop database), CouchDB, MangoDB, Apache Cassandra , Apache Ignite

*C. Data Filtering and noise Elimination* - This phase is dedicated to removing duplicate, corrupt, redundant and irrelevant data objects from aggregated information. However, filtered and extracted data may be of some importance in another context or analysis. Therefore, it is best to keep a copy of the original data set in compressed form to save storage space.

### Pentaho , OctoParse, ParseHub, Mozenda

*D. Data Classification and Extraction-* This step is responsible for extracting the integral data and converting it into normal data format which the built-in analytical tool can use for its intended purpose. .

List of classification tools used

### DataCleaner , MapReduce, Rapidmine, OpenRefine

*E.Data cleansing, validation and aggregation*

- This step applies to business-based authentication rules to confirm the need and relevance of the data drawn for analysis. Although sometimes it can be difficult to impose authentication restrictions on extracted data due to complexity. Aggregation helps to combine multiple data sets into smaller numbers based on common fields. This simplifies further data processing.

List of analysis tools

### Hive, Apache Spark, Apache Storm, Map Reduce, Qubole

*F. Data Analysis and Processing* - This phase mining and analyzing real data to establish unique and hidden patterns for business decision making.

### Data Wrapper, Tableau, Orange, Qlik, Google Fusion tables, CartoDB

*G. Data Visualization-* This stage represents the results of the analysis in visual or graphical form which makes it easier for the audience to understand.

### Conclusion :

Big Data analysis is a very big issue so it necessary to use and apply the innovation Big Data Analytical tools in every phase. The analysed data is so important and it needs pure filtering so it can forward to better decision making models.

### References:

[1] Ms. Komal "A Review Paper on Big Data Analytics Tools", International Journal of Technical Innovation in Modern Engineering & Science ,IJTIMES, e-ISSN: 2455-2585, Volume 4, Issue 5, May-2018, Page no.1013-1017

[2] Samiddha Mukherjee<sup>1</sup>, Ravi Shaw<sup>2</sup>, " Big Data – Concepts, Applications, Challenges and Future Scope", IJARCCCE, International Journal of Advanced Research in Computer and Communication Engineering, Vol. 5, Issue 2, February 2016, ISSN (Online) 2278-1021 ISSN (Print) 2319 5940, Pageno,66-74

[3] www.simplilearn.com, Top 10 Big Data Applications Across Industries

## Smart Farming using IOT

Priyanka Vijay Barhate<sup>1</sup>, Karishma I. Kale<sup>2</sup>  
**Asst. Professor,**

Department of Computer Science  
 DNCVP's ShirishMadhukarraoChaudhari College, Jalgaon

**ABSTRACT:**

*In India day by day agriculture sector is gradually diminish due to unstable environmental parameters and insufficient labors, which affect the productivity and overall economy of the agriculture sector. There is extreme need to solve this problem in the domain to restore energy and put it back on higher growth. To improve efficiency, global market, productivity and also to reduce human effort, time and cost, there is need to divert towards new technology which is Internet of Things (IOT). In real time smart farming improves the entire agriculture system by observing the field and also with the help of sensors and interconnectivity, the IOT in agriculture has not only saved the time of the farmers but it has also reduced the excessive use of resources such as water, electricity and labors. This paper describes some technology like sensing technology, communication technology, data analytics etc. and IOT base farming cycle which is used to optimize the farming process and also describe the applications of agriculture to become smart farm.*

**Keywords:** Smart farming, Sensor, IOT

**Introduction**

The IOT means internet of things, IOT brings the power of the internet, data processing and analytics to the real world of physical object. There are the many difference between traditional farming and smart farming. In traditional farming Same set of practices for cultivation of a crop throughout the region as compare in smart farming Each farm is analyzed to see the suitable crops and water requirements for optimization **Smart Farming** is a concept of farming

management using modern Information and Communication Technologies to increase the quantity and quality of products. IOT discovered many of techniques for farming which increase the potential and productivity of farms.

**Technologies involve in smart farming-**

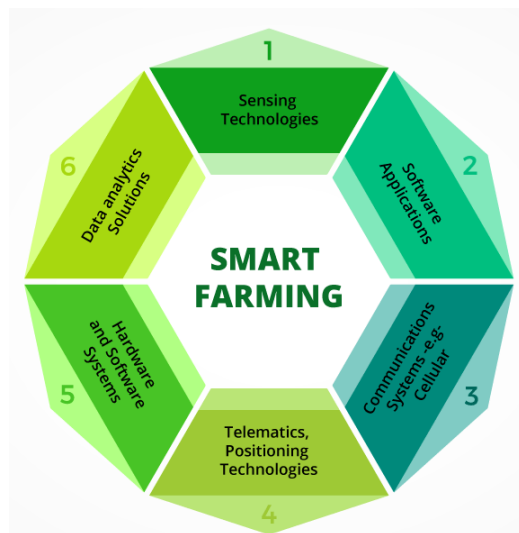

[Ref-<https://www.iotforall.com/smart-farming-future-of-agriculture/>]

- 1) Sensing technologies- Sensing technology includes soil scanning, water, light, humidity, temperature management.
- 2) Software applications — There are some specialized software solutions are available that target specific farm types.
- 3) Communication technologies- It includes such as cellular communication.

- 4) Positioning technologies- GPS technology is very useful for smart farming.
- 5) Hardware and software systems that enable IoT-based solutions like robotics and automation.
- 6) Data analytics- that underlies the decision making and prediction processes.

### ***Farming Cycle based on IOT***

To optimize the farming process IoT devices are installed on a farm. And it should collect the data and process data in a repeated cycle that enables farmers to quickly react on that issues and changes in ambient conditions. These cycles are in 4 stage, after evaluation the cycle start from beginning

1. **Observation** — sensors collect the observational data from the crops, livestock, the soil or atmosphere.
2. **Diagnostics** — the sensor values are fed to specific software with predefined decision rules and models that ascertains the condition of the examined object and any deficiencies or needs.
3. **Decisions** — after issues are revealed, the software determines whether location-specific treatment is necessary.
4. **Implementation** — the treatment needs to be performed by means of the correct operation of machines.

### ***IOT Applications in smart farming and agriculture***

#### ***1) Climate Condition***



[ref-<https://www.biz4intellia.com/blog/5-applications-of-iot-in-agriculture/>]

Climate plays an important role for farmer .Weather stations equipped with smart sensors which collect weather data and send useful information to a farmer. Moreover, the information is analyzed by special software and the farmer gets ready-made analysis that helps him have a detailed forecast and avoid crop losses.

#### ***2) Precision farming***



[ref-  
<https://www.downtoearth.org.in/blog/agriculture/why-farmers-today-need-to-take-up-precision-farming-64659>]

IOT based precision farming technique identifies, analysis and manage various fields like crop production practices at right place and time or in right way. Therefore the farmer gets optimum profitability and protection of land resources. The goal of precision farming is analyze data which is collected through the sensor and take the action according to this. Precision farming helps to farmer with the help of sensor to collect the data. Livestock monitoring, vehicle tracking, filed observation are the applications of precision farming. Precision farming prevents the soil degradation.

#### ***3) Smart greenhouse***



[ref-<https://r-stylelab.com/company/blog/iot/iot-agriculture-how-to-build-smart-greenhouse>]

Traditional greenhouses control the environmental parameters through manual involvement or a proportional control mechanism which often effects on production loss, energy loss, and increased labor cost, as compare IOT

---

driven smart greenhouse controls the climate, eliminating the need for manual intervention. so, different sensors that measure the environmental parameters according to the plant requirement are used and store it in a cloud for further processing and control with minimal manual intervention. In smart greenhouse to control the environment different sensors are used that measure the environmental parameters according to the plant requirement.

#### 4) Agricultural drones



[Ref-<https://uavcoach.com/agricultural-drones/>]

Drones become a vital part of smart farming. they helps farmer in wide range of challenges. drone construction includes propulsion and navigation systems, GPS, sensors and cameras, programmable controllers as well as equipment for automated flights. The technology used in drones for agriculture is built in a way that enables them to capture more accurate information than airplanes. Drone-based agricultural software processes the collected data and delivers it in an easy-to-read format.

Uses of agricultural drones

- i. Controlling overall crop health
- ii. Scouting land and crops
- iii. Managing livestock and monitoring for health issues
- iv. Checking for weeds and spot treating plants.

#### *IOT challenges in agriculture*

1. Connectivity
2. Design and durability
3. Limited resources and time

#### *Conclusion-*

IOT technology is very helpful to farmer to gather the important information which leads to improvement in quality of their crop. also the tracking vehicles are available so farmer done his work in minimum labor so it is economically beneficial. IOT enabled agriculture has helped implement modern technological solutions to time tested knowledge. This has helped bridge the gap between production and quality and quantity field.

#### *References-*

- 1) [JashDoshi](#)  
[.Tirthkumarpatel,SantoshkumarBharati](#)“Smart farming using iot.,a solution for optimally monitoring farming conditions “ 3<sup>rd</sup> international workshop on recent advances on internet of things :technology and approaches
- 2) VinayakN.Malavade ,Pooja K. Akulvar, “Role of IOT in Agriculture” IOSR Journal of computer Engineering e-ISSN2278-0661,p-ISSN: 2278-8727 PP 56-57
- 3) <https://medium.com/sciforce/smart-farming-or-the-future-of-agriculture-359f0089df69>  
<https://www.cropin.com/smart-farming/>
- 4) <https://www.iotforall.com/iot-applications-in-agriculture/>
- 5) <https://www.biz4intellia.com/blog/5-applications-of-iot-in-agriculture/>

## An Overview of Blockchain Technology in Education System

**Vasundhara R. Fegade**

Asst.Prof., Department of Computer Science, Dhanaji Nana Mahavidyalaya, Faizpur  
KBC North Maharashtra University, Jalgaon (India)

[vrfegade@gmail.com](mailto:vrfegade@gmail.com)

### ABSTRACT:

*Blockchain is an emerging technology with very huge capabilities to affect every part of our lives, specially for transaction or keep records. Blockchain is distributed, decentralized most secure permanent piece of information. This technology is used for secure information storage sharing and networking. Using this technology many processes become faster, safer and easier. Now a days education moves fast beyond smart boards and remote learning. In this paper I mention how and where this technology can be used in education system. Today many state educational institutions are in the planning process for implementing blockchain basic tools and there will be need who work in educational field be aware of this.*

### Keywords-

*Blockchain Technology, Transaction, Record Keeping, Education System.*

### Introduction:

“Blockchain is, in the simplest of terms, a time-stamped series of immutable records of data that is managed by a cluster of computers not owned by any single entity. Each of these blocks of data (i.e. block) is secured and bound to each other using cryptographic principles (i.e. chain).” The blockchain database is not stored in centralized location rather it keeps public and easily verifiable. No centralized version of block exist for hacker to corrupt. If the hacker corrupt one copy of block then before transaction each copy must be verified in blockchain technology. Hence the fraud can be easily detected. Many copies of the block scattered over network achieving decentralized approach.

Blockchain is the combination of three technologies:

1. Cryptographic key
2. A peer-to-peer network containing a shared ledger.

3. A mean of computing to store and record transaction.

### Uses of blockchain in the following educational areas:

#### 1. Security and Verification:

As more school, colleges and universities go digital there is importance to ensuring students privacy. Security and verifications is so important both on college campus and after student leave to enter the workforce. The student record and information is used to create fake identities or be sold by hackers. If this record is stored in blockchain it could be protected and make this attack ineffective and protect student identities.

Another use of this security protocol in education has defending employers against people have a fake degree or degree or others. Such a people telling lie about their degrees and qualifications to employers because there is difficult to verify their degrees and qualifications under current system. When student enters the workforce blockchain could be used to assure employer that the student gives the correct information as mention in their resume by storing that information in a secure ledger i.e. blockchain.

#### 2. Improve Record Keeping:

One of the most promising use of blockchain in higher education is for “Record Keeping” of degrees and certificates under the learner control without any intermediary to verify them.

Blockchain can also be used for accreditation of educational institutions by verifying quality and qualification of teaching. If record keeping is perform using blockchain it solving intellectual property (IP) management problems. For example using blockchain it is possible to determine if an idea or invention is unique or to register IP assets, patent and copyrights.

---

### 3. Use of digital assets in student payments:

Processing student payment involve student, parent ,financial institution, scholarship agencies Government and educational institution.In future cryptocurrencies are used as method of student payment

In 2014 King's college in New York city became the first accelerated U.S. institution to accept Bitcoin as payment eliminating credit card transaction fees previously charged to students .

### 4. Partnership platform :

Blockchain provides platform for sharing and communication.Relationship between student and professor are crucial. When learner get enough advice and personal guidance they can study without paying someone to do the assignment. For that purpose blockchain based platform allows department to post information about important lectures and events. This ensure efficient relationship between student and professor and also long- term relationship between alumni and faculty

### 5. Copyright and digital right protection:

Plagiarism is a serious problem in educational world. Blockchain technology can be used to control the dispersal of copyrighted material across the internet. As blockchain is secure storage of information recorded in a chain ,data within the chain cannot be altered by third person because it use advanced encryption measures. This will make the the educational material accessible but not changeable. The utilisation of educational material can be tracked online and ownership can be easily proved.

### 6. Innovation learning platform:

One of the best use of blockchain in educational sector is learning platform. For example, the education ecosystem platform is one of the best project that use blockchain to connect

academician, developer, student and content producer.Using this ecosystem learner can get access to study material and share their product and Idea.The internal token are used in this system to download books and requested study materials. These token are earned when use her invite new participants, watch videos.Content creator received reward after when people interact with their content in the form of new tokens. As such the more learner learn and practice, the more material he get to continue learning .Using such learning process the student's interest in learning increases and they study more and more.

### Conclusion:

To sum up, the blockchain technology can improve the educational system in many ways, with the help of this advanced technology many processes in education system become faster, easier and safer. The technology is perfect for storing secure information storage , sharing and networking. This is best for credentialing copyright protection and efficient communication. We should welcome this innovative technology in education system to make our future better.

### References:

1. <https://jaxenter.com/blockchain-education-161738.html>
2. <https://dataconomy.com/2019/01/how-will-blockchain-transform-the-education-system/>
3. <https://www.gartner.com/smarterwithgartner/4-ways-blockchain-will-transform-higher-education/>
4. <https://taxguru.in/rbi/what-is-blockchain-technology.html>
5. <https://blockgeeks.com/guides/what-is-blockchain-technology/>

## Overview of Learning Management System in Higher Education

**Mr. Harshal V. Patil**

DOCS Bhusawal Arts, Science & P.O.Nahata Commerce College, Bhusawal, India  
harshal4patil@gmail.com

**Dr. B. H. Barhate**

barhate\_1@yahoo.com

### ABSTRACT:

*This paper discusses the successful online learning of Learning Management System (LMS) Impact of interactive and learning structures enabled by different LMS on online solutions and learner investments Course. Learning Content Management System (LCMS) is an integrated multi-user administrative, authoring, and distribution platform. It allows administrators to host, create schedules, manage registrations, evaluate, test and track online training activities. These systems also allow instructional designers and course materials creators and educators to access the course schedule, register for training, take assessments, and manage transcripts. This paper helps you to understand the basic functionality of LMS and how these are helpful in eLearning.*

**Key words:** LMS, LCMS, e-learning, HEIs.

### 1. Introduction:

In this Covid 19 lockdown period with social distancing e-Learning is a very good medium of getting together through e-platform. Today's large demand of internet applications requires data to be transmitted during a secure manner. The amount of knowledge in world is growing day by day. Data is growing due to use of internet, smart phone and social network. ICT-supported education represents an approach that is currently considered common and comprehensive adopted a learning path (sometimes even preferred).

The Learning Management System (LMS) consists of a set of tools and partial software which enables applications to mimic the actual teaching / learning environment Learners to learn from anywhere and at personal speed 365/24/7. It has applications in educational technology and higher

education Contributed to the development of LMS. Since the first LMS was implemented in 1990's. In the 1990s, higher education became an integral part of institutional life communication plans, lecturers, teaching and students learning experience.

Although LMS plays a key role in lecturer-student communication in HEIs, Inconsistency, lack and lack of organization when managing technical resources Integration is one of the most serious problems. It is time to prioritize upper primary institutions Coordination, organization, integration and interoperability of LMS Assisting technology for teaching and learning as one of the basic occupations for anyone HEIs.

### 2. E-Learning:

The "e-learning" was defined in alignment with a definition by Rosenberg. According to Rosenberg, the first and most important feature of e-learning is that it takes place in a network environment. This means that the teacher's computer is constantly communicating with the central server. Also e-learning content is accessible on personal computer through internet browser. Whether it is a traditional educational institution or a corporate training setup, the growth of e-learning has also had an impact on the way people learn and communicate in a learning environment.

As a result, educational materials are designed, developed, and there are many groups to reach out to those who want to learn in a certain educational environment. This includes people: writers and learners, who are key players, and administrators and coaches. Author teachers or instruction-learning content designers can create e-learning content using one writing system.

### 3. LMS in Higher Education:



Learning Management Systems are used all over Higher Education Institutions (HEI) in the world and the need to know and understand its adoption and usage arises. On the one hand there are different institutional cultures and Features and, on the other hand, are many explicit LMS tools. In previous years, the proprietary platform was the most used but currently there is an increase in the use of open source open platforms. Consequently, there are not many studies regarding the usage level of such tools, concerning students, teachers, tools functionalities, usability, and the entire technological environment.

Generally both proprietary and open source Free LMS provides a number of functions, such as, Course syllabus, grades and electronic distribution ability for teachers to post feedback, hyperlinks to students, websites, ideas exchange forums, wikis which Allows students to exchange ideas and information on projects, Chat room for real time discussion, email facility and messages among participants (teachers / students, Student / students), facility for students to submit work Electronic assignments, tools of administration Quizzes and texts online. It is frequent to observe that despite LMS on HEI is offered and usage stimulated, only a few of those functionalities are adopted, either by teachers, or by students.

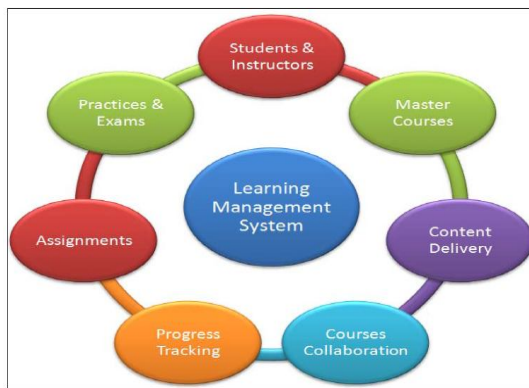

Figure - 1 Learning Management System (LMS)

#### 4. Need or Role of LMS:

With LMS, the need for a system to accommodate all educational styles and levels can be met. Teachers can organize their classes and their students can get different documents, assignments, tests etc. to work for them without knowing that they are getting something specially developed for their own level can post.

Many colleges are trying to streamline the courses taught by different teachers through general lessons and assessments. With LMS, teachers can collaborate on lessons, activities and assessments and easily share these activities. Groups can be formed on LMS for teachers to share resources with specific colleagues.

**Teachers:** For teachers, LMS has many advantages over mid-level education. Their organizational center is to upload for students everything that teachers do in the classroom. Gone are the days when students had to get copies of their absent work papers; Now teachers post worksheets, links, videos and other resources for teachers to access home and school on LMS. Worksheets, tests, quizzes, as well as grade submissions of these assignments are saved in LMS. Tracking student progress, attendance and class materials is all in one place. What could be better than this? The latest movements in technology education are supported since blended learning and flipped classrooms can be created and posted in the LMS.

**Students:** Regarding student benefits, most students are attracted to out-of-college technology; Therefore, LMS is perfect. Teachers can load educational apps on LMS to help students with solutions and reviews. Students can also add apps to notify via LMS when teachers add something to the course or send a class message. There is also a built-in reward system in which teachers can give badges to students for good attendance, participation, etc. to reinforce positive behavior.

Through the messaging system that LMS offers, students have the opportunity to interact with their teachers and post questions to their teachers or other classmates for answers. Also, the calendar in LMS will help organize students; teachers post upcoming tests and assignments, and club directors post upcoming events.

**Parents:** Through LMS, parents can view their child's curriculum and all posted by teachers. Parents can stay up to date on their child's assignments by looking at the calendar. In addition to grading tests and quizzes, parents can see the tasks your child is completing each day. Summarizing their child's course content, calendar, grades, and attendance in one place meet most parents' questions, thus reducing the amount of explanatory emails teachers need to answer. Parents can hold their child responsible at home and oversee the completion of their work without the city.

#### 5. LMS – Open Source Software:

The most popular and very widely used Learning Management Systems today are: BlackBoard, WebCT, Angel, LAMS, Moodle, Sakai Project, and other less know ones: Desire2Learn, FirstClass, IntraLearn, Jones Knowledge, Manhattan project and many others. Below is given a statistical usage of some popular LMSs in colleges today

#### 6. Challenges of LMS:

The Challenges of LMS are as follows:

- **Analytical models and theories:** Lack of models and theories to analyze the current learning environment and usage Educational technology

---

like LMS is a challenge facing many organizations. A theoretical framework is essential for the design of 21st century learning experiences and models to guide the study of e-learning in higher education. This it is important to adopt this model to provide better knowledge of organizations. Management when making decisions related to the environment described by Model.

- **Planning and strategies for the implementation:** Higher education institutions lack planning and strategies for implementing educational technology Significant challenges highlighted by researchers in educational technology. Planning for Success can be achieved with the right educational technology and integrating it into LMS Implementation of LMS for teaching and learning. In order to build the next generation of LMSs, the HEIs must be prepared to focus on crafting the implementation plans, policies, and strategies to provide the solutions for managing the current situation while demonstrating how it can overcome the challenges and demands of the future LMS. It is vital to integrate technology planning as a major component of the overall vision and strategy for the HEIs.
- **Technology integration:** Failure to integrate LMS with other support technologies can lead to failure Management of educational activities in a digital learning environment. The integration of different tools into LMS posed a challenge. It is believed that the LMS can be integrated with other systems to increase the efficiency of teaching and learning. Integrating technology into the curriculum is essential and it is important to adopt it Investment in technology is the main strategy of the organization.
- **The Lack of inclusiveness of academics in the implementation:** An LMS will not guarantee the effective use of the technology in the teaching and learning. In order to improve the effectiveness, efficiency, and sustainability of the LMS, it is necessary to engage the academics at the beginning of the implementation process.

## 7. Advantages and Disadvantages of LMS:

**Advantages of LMS:** LMS has six main advantages: interoperability, accessibility, reusability, durability, maintenance capability and

adaptability, which form the concept of LMS itself.

Other advantages include

- An LMS supports content in various formats: text, video, audio, etc
- One can access materials anytime, from everywhere, teachers can modify the content, and students can see the updated material.
- The evaluation of students is easier and fair, based on student attendance and online quizzes.
- Students and teachers can re-use the material every time they need.
- Students can learn collaboratively by setting up a college website with LMS software and "helping to keep institutions up to date with compliance rules."

### Disadvantage of LMS:

- Implementing LMS requires a well-built technology infrastructure.
- The cost of implementing or installing LMS is very high.
- Teachers have to be willing to adapt their curricula from face to face lectures to online lectures

## 8. LMS for BASPONC College, Bhusawal:

With a view to promote Quality in Higher Education in the rural area of Bhusawal Tahasil of Jalgaon District (earlier known as East Khandesh). Tapti Education Society has been promoted by social workers and Philanthropists way back in 1958. The Bhusawal Arts, Science and P. O. Nahata Commere College, Bhusawal was then established by Tapti Education Society in 1963, the first college in Bhusawal Tahasil. The college has made a remarkable contribution in imparting Quality Higher Education for uplifting different sections of the society surrounded by rural and agricultural background.

Wide range of courses, dedicated and experienced research oriented faculty, well developed infrastructure, a rich academic and cultural ambience, enriched library, well developed modern laboratories, modern student centric teaching learning methods, social commitment, enrich student support services are some of the prominent features of the college. Our college got accredited in 2001, 2008 and in 2014 consecutively and achieved \*\*\*\*, A(CGPA 3.28) and A(CGPA 3.30) respectively; thus being the first college in North Maharashtra University Jalgaon jurisdiction to achieve hattrick of 'A' Grade.

BASPONC College, Bhusawal uses the e-Learning Management System, Google Classroom, etc. Now we implement our own small learning management system for our college is as follows

Top Education Society's  
**BHUSAWAL ARTS, SCIENCE AND P. O. NAHATA COMMERCE COLLEGE, BHUSAWAL**  
 NAAC Re-accredited 'A' Grade with CGPA 3.28  
 UGC honoured 'College with Potential for Excellence'

Online COVID-19 Awareness Programme Organized by IQAC BASPQNC Bhusawal - Click Here

HOME ABOUT ADMINISTRATION ACADEMICS LIBRARY RESEARCH NAAC IQAC NIR FACILITIES FEEDBACK STUDENT STAFF LOGIN

### Learning Management System

- Video Lecture
  - Arts Faculty
  - Commerce & Mgt. Faculty
  - Science Faculty
- e-Material
  - Arts Faculty
  - Commerce & Mgt. Faculty
  - Science Faculty

### LMS - Sub Menu

- Video Lecture
  - Arts Faculty
  - Commerce & Mgt. Faculty
  - Science Faculty
- e-Material
  - Arts Faculty
  - Commerce & Mgt. Faculty
  - Science Faculty

Department Of Computer Science & I.T.: Video Lectures

Software Engineering Video Lect 1  
By Dr. B. H. Barhate

Software Engineering Video Lect 2  
By Dr. B. H. Barhate

Data Structure - Stack  
By Prof. Harshal V. Patil

### LMS - Sub Menu

- Video Lecture
  - Arts Faculty
  - Commerce & Mgt. Faculty
  - Science Faculty
- e-Material
  - Arts Faculty
  - Commerce & Mgt. Faculty
  - Science Faculty

Department Of Computer Science & I.T.: E-Material

Network Security  
(Skill Enhancement Course)  
By Prof. Dr. B. H. Barhate - Click Here

Natural Languages Processing  
By Prof. Harshal V. Patil - Click Here

Web Designing (Java Script)  
By Prof. Harshal V. Patil - Click Here

### LMS - Sub Menu

- Video Lecture
  - Arts Faculty
  - Commerce & Mgt. Faculty
  - Science Faculty
- e-Material
  - Arts Faculty
  - Commerce & Mgt. Faculty
  - Science Faculty

Welcome Yogesh Vishwanath Patil

BASPQNC / Online Test Series System

### Online Test Series System

In this system there are two types of Test.

- Multiple Choice Test
- Descriptive Type Test.

Students solve multiple choice test online and get the result after attending the multiple choice questions.  
 Student solve descriptive type test at the home like home assignments.

You are @ Online Test Series System Home Page

Copyright 2020 baspncollege.org | Design and Developed by Prof. Dr. B. H. Barhate and Mr. Harshal V. Patil

This is Practice Test Series. (Home Assignment)

Class Name: **B.Sc.** Learning Year: **III**

Select Semester Name: **Sem-IV** Select Subject Name: **Computer Science** Select Paper Name: **Internet Programming unit**

Select Your Test Name: **CS PHP Test - 2** Teacher Name: **Mr. Harshal Vishwanath Patil** Total Question: **10** Total Marks: **50**

**This is Practice Test Series. (Home Assignment) Attempt All Questions.**

- Write short notes on Interface in PHP? 5 M.
- Explain following MYSQL function 1) mysql\_connect() 2) mysql\_query() 3) mysql\_fetch\_array() 5 M.
- What is Session? Explain any two session function? 5 M.
- What is interaction between PHP and MYSQL? 5 M.
- Write short notes on Exception Handling in PHP? 5 M.
- Write short notes on Constructor and Destructor in PHP? 5 M.

Class Name: **B.Sc.** Learning Year: **III**

Select Semester Name: **Sem-IV** Select Subject Name: **Computer Science** Select Paper Name: **Internet Programming Unit**

Select Your Test Name: **Internet Programming Unit** Teacher Name: **Mrs. Kshobha pramod dhole** Total Question: **60** Total Marks: **120**

**Attempt All Questions.**

- PHP stands for.....  
 1. Hypertext Preprocessor  
 2. Personal Home Page  
 3. both 1 and 2  
 4. Personal Hypertext Page  
 Select Your Option: **3**
- PHP is \_\_\_\_\_ side scripting language  
 1. server  
 2. client  
 3. server-client  
 4. both 1 and 2  
 Select Your Option: **1**
- PHP files have a default file extension of \_\_\_\_\_

---

## Conclusion:

This study found that the use of LMS in teaching and learning, in HIE's in the Maldives More focused on passive aspects of learning as LMS components are frequent Assignment Management, Course Management, Course Content Sharing and Information sharing. Virtual learning environment is the future in the field of education, not only for higher education but also secondary Education is where their identity lies. Universities all over the world and use new ones every day Applications have been added to the virtual learning platform. The aim is to improve efficiency and communication in students.

## References:

- [1] LMS Definition available at: <http://www.nationaltrainingsoftware.com/lmsdefinition.html>.
- [2] Ellis, Ryann K, Field Guide to Learning Management Systems, ASTD Learning Circuits, (2009)
- [3] LMS Definition available at: <http://searchcio.techtarget.com/definition/learningmanagement-system> (2002).
- [4] Lang, L. and Pirani, J. A. The Learning Management System Evolution, Educause, 2014. <https://library.educause.edu/resources/2014/5the-learning-management-system-evolution>
- [5] Brown, M., Dehoney, J., and Millichap, N., What's Next for the LMS?, 2015. <http://er.educause.edu/articles/2015/6/whats-next-for-the-lms>.
- [6] Garrison, D. R., E-Learning in the 21st Century: A Community of Inquiry Framework for Research and Practice, 3rd Edition. UK: Routledge, 2016.
- [7] Lever-Duffy, J. and McDonald, J. Teaching and Learning with Technology, 5th Edition. USA: Pearson Education, 2015.
- [8] Bates, A. W. and Sangra, A. Managing Technology in Higher Education: Strategies for Transforming Teaching and Learning. San Francisco: John Wiley & Sons, 2011.
- [9] S. Ghavifekr and S. Hussin. Managing Systemic Change in a Technology-Based Education System: A Malaysian Case Study. Procedia- Social and Behavioral Sciences, Nicosia/Kyrenia, 2011, pp. 455-464.

## Decision Support System :A Better Tool For Managing E-Business

**Mrs. Renu Patria**

*Computer lecturer in S.S. Jain Subodh Girls Pg. College Sanganer , Jaipur  
L-902, Vrinda Gardens, Near RTO, Jagatpura, Jaipur (Rajasthan) INDIA  
[renu.patria@gmail.com](mailto:renu.patria@gmail.com)*

### ABSTRACT:

*In the present era, a Decision Support System act as a ventilator to support different activities related to business. It is a set of human or computer based model to support analysts and decision makers in making better and faster decisions in any sort of business activities.*

*In today's scenario , DSS plays a vital role in managing e-business , DSS is an important tool of information management system that is basically designed to run business process smoothly at different level of managerial hierarchy (All stake holders including CEO's , senior managers and executives ).*

*As mentioned above, the role of DSS becomes more prominent and it is quite evident in today's COVID era where the entire face to face business transactions have shifted to digital mode . The web platforms like Zoom, Webex and Google meet have been extensively used right from big corporate giants to semi – government and government institutions .*

**Keywords-***Decision support system, Management Information System, Decision Making, Digital Mode, Semi-government*

### I. INTRODUCTION

A particular system which support the process of decision making is called decision support system. It is not an automatic system but act as a supporting system because it provides different type of quantitative and qualitative data , then the decision maker analyze the data and take a better decision. DSS helps the manager at different level of decision making process like problem identification ,selection of related data ,use right approach, examining alternatives and choosing the best alternative solution.

Today different types of DSS models are available in the marketplace and we can choose according to our business need like knowledge base model, data base model, user interface mode.

### II. CHARACTERISTICS OF DECISION SUPPORT SYSTEM

- DSS provide support for decision maker in unstructured and semi-structured situation by the help of computerized information or by different quantitative method or by data analytical tools.

- DSS support to all level of managerial hierarchy from top executives to line managers.

DSS can be implemented in all phases of decision making process like intelligence, design, choice, and implementation. DSS is more flexible and adaptive system because decision maker easily retrieve , update, delete, change and rearrange basic elements

DSS provide graphical and user friendly interface, it increase the effectiveness of decision making rather than its efficiency (cost of decision making)

DSS can be utilized in a different variety of decision making processes, styles and design.

DSS does not replace the decision maker but plays a good supporting role.

DSS would help both groups and individuals .In order to solve some unstructured problems, user may take help from people from different departments and from different organizations.

Both sort of sequential decisions as well as interdependent decisions can be taken through DSS.

### III. APPLICATIONS OF DSS

Below are the different applications of DSS used by different types of business users.

1. **Intelligence Report-**As DSS is a computer network, professionals uses DSS to collect and analyze intelligence which provides information about decision they make. Different computers collectively make the decision support system and fetch the data from different resources unlike conventional database. The system then shows the data to users in their format. DSS plays a major role in management decision making for long term growth. For example, manager and executives deals with intelligence report before entering in new market. They consider different thing like competitor behaviors, market projections and economic outlook.

**Medical Industry-**Review of past historical medical reports, the medical professionals find it easy to diagnose the health problems. They use DSS to pull the data rapidly from the different sources and present a diagnosis result depending upon several factors. Fetching the data from the conventional database for diagnose generally takes more time in the absence of decision support system.

3. **Agriculture Industry-**The decision support systems are also applicable in the agriculture sector. The farmers, biologists and other specialists use such system in order to collect data such as proper timing of seeding, market price of crop, weather condition, and policies that are helpful in marketing plans. Many farmers and agriculture professionals who generally work

at small level of agriculture field look over the government relief for funding in this technology because the cost of DSS is very high.

**Air Traffic Control**-Air traffic professionals also use the decision support system. Decision support system is a computer network that helps in managing several planes travelling in the particular areas. These systems also support in monitoring the weather. Air professionals generally collect information such as current weather, future weather, decision of routes and weather reports nearby regions quickly by using decision support system.

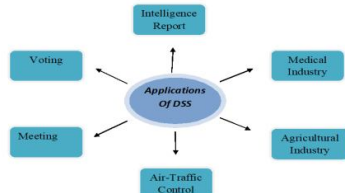

#### Applications Of Decision Support System

4. **Meeting**- A person involved in the meeting also uses the decision support system. Because of this systems are also known as group decision support system. Such models help the individuals to show their view in the meeting. The different views of group members are considered by the leader and he/she discusses the different possible results to a problem. In the present lockdown period, we use different types of e-meeting platforms like Zoom, Google Meet, What's App, etc

5. **Voting**-Decision support system also helps in simplifying the voting process. This is basically used in the big organizations where voting policy is fascinated by Board Of Committee members. Every Committee member places their vote on a computer on which he/she works. The group leader has authority to see the votes while members cannot see other members vote. Group leader manages the entire process of voting through Decision Support System.

#### IV. COMPONENT OF DECISION SUPPORT SYSTEM

In any organization decision support system consists of three basic components; Data base management system, DSS software system, DSS user interface.

**DSS Database System**-Database system contains data from different sources like internal data access from the organization, and it is generated by different computer application in different departments, and external data access from the internet, government record etc. Decision support database may be small, huge, standalone according to the organizational information need. In database library data is stored and retrieve by a database web server

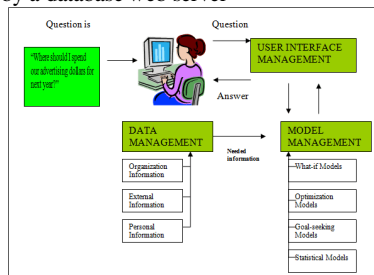

1. **DSS software System**-It is also called Model base system, it contain various mathematical and analytical models that help to analyze the complex data and after this producing information according to user need. It is a combination of different statistical, financial and quantitative model that predicts the output in the basis of different inputs or different business conditions.

A decision support system is a combination of different models where each model performs some specific function so selection of model depends on the user requirement. DSS software design a number of models that supports in specific type of decision in decision making process like:

- Statistical Models
- Sensitivity Analysis Models
- Optimization Analysis Models
- Forecasting Model
- Backward Analysis Sensitivity Models

2. **DSS user interface** – It provide an interactive graphical user interface which makes physical link between the DSS and user. It shows the outcomes of the analysis in various syntax and semantics like text, chart, table, graphics .The user can easily select an appropriate mode of display output according to user requirement.

#### V. CONCLUSION

Decision support system is a computerized information system and it is used in decision making process to take a better decision in e-business. All business activities or departments use different DSS model according to business requirement and that helps them to take a better decision. In this paper we discuss about the role of DSS in different business application and key component of DSS.

Decision support system is a very important tool of management information system .It is used when decision making process need real time dynamic mode, all such systems are designed to read, evaluate, maintain, analyze and act as per the decision guidance in the system.

#### ACKNOWLEDGEMENT

I would like to express my deep and sincere gratitude to Professor Ajay for his valuable and constructive suggestions during the planning and development of this research work. I would also like to thank Mr. Manish for sharing real time experience and enabling me to observe their daily operations related to research work

#### REFERENCES

- [1] Power, D. J. and R. Sharda. 2007. Model-driven Decision Support Systems: Concepts And Research Directions. *Decision Support Systems*. 43(3): 1044-1061.
- [2] Keen, P. 1987. *Decision Support Systems: The Next Decade*. *Decision Support Systems*. 3: 253-265.
- [3] Keen, P. and M. S. Morton. 1978. *Decision Support Systems: An Organizational Perspective*. Addison-Wesley Publishing.
- [4] Shim, J. P., M. Warkentin, J. F. Courtney, D. J. Power, R. Sharda, and C. Carlsson. 2002. Past, Present, And Future Of Decision Support Technology. *Decision Support Systems*. 33(2): 111-126.
- [5] Marakas, G. M. 2003. *Decision Support Systems In the 21st Century*. Pearson Prentice Hall.
- [6] Eom, S. and E. Kim. 2005. A Survey Of Decision Support System Applications (1995–2001). *Operational Research Society*. 57: 1-15.
- [7] Oguduvwe, J. I. P. 2013. Nature, Scope and Role of Research Proposal in Scientific Investigations. *IOSR Journal Of Humanities And Social Science (IOSR-JHSS)*. 17(2): 83-87.
- [8] Cronin, P., F. Ryan, and M. Coughlan. 2008. Undertaking A Literature Review: A Step-By-Step Approach. *British Journal of Nursing*. 17(1): 38-43.
- [9] Gupta R. C., *Management Information Systems*, CBS Publishers & Distributors, New Delhi.
- [10] Indrajit Chatterjee (2010). *Management Information Systems*, Prentice Hall of India, New Delhi.
- [11] Jawadekar, W. S. 1998, *Management Information System*, Tata McGraw Hill Publishing Company Ltd. New Delhi.
- [12] Lordon K. L., *Management Information System*, Prentice Hall of India, New Delhi.
- [13] Lucas, H. C., Jr. (1990), *Information systems concepts for management*. New York: McGraw-Hill.

## Performance based analysis of various image segmentation techniques

**Shubhangi K. Patil<sup>1</sup>**,  
Assistant Professor<sup>1</sup>,  
Department of Computer Science<sup>1</sup>,  
Dhanaji Nana Mahavidyalaya, Faizpur<sup>1</sup>

**Dr. B. H. Barhate<sup>2</sup>**,  
Associate Professor<sup>2</sup>,  
Department of Computer Science<sup>2</sup>,  
Bhusawal Arts, Sci and P.O.Nahata  
Comm. College, Bhusawal<sup>3</sup>

**Dr. Gouri M. Patil<sup>3</sup>**  
Assistant Professor<sup>3</sup>,  
Department of Computer Science<sup>3</sup>,  
Bhusawal Arts, Sci and P.O.Nahata  
Comm.College, Bhusawal<sup>2</sup>

### ABSTRACT:

*One of the most challenging tasks in digital image processing is image segmentation. Image segmentation is the process of subdividing image into a constitute parts or object present in it. Extracting various objects or regions of the image used for analysis of image the fundamental objective of image segmentation. This paper presents the analysis of various segmentation techniques such as edge detection, thresholding, region based segmentation and feature based clustering segmentation. Besides this some of the image segmentation techniques are tested on microscopic blood smear images.*

**Keywords-** Image Segmentation, Edge detection, Thresholding, Clustering.

### I. Introduction

Now a day a role of image processing in medical field increases exponentially. Medical imaging has made an excessive impact on diagnosis and treatment. The most important part of image processing is image segmentation.

Image segmentation is a process of dividing image into multiple segments such as set of pixel, pixels in region that are similar to each other to extract and identify different objects or regions in an image. Segmentation is basically categories on the basis of discontinuity and similarity of pixels in relation to their local neighborhood. The famous techniques of image segmentation are edge detection, thresholding, region based methods and features based clustering methods. Image segmentation application area includes robotics, medical diagnosis, locate object in satellite images, finger print recognition, face recognition, character

recognition etc. The result of image segmentation is affected by noise, low contrast, non-uniform illumination and irregularity of object's shape within the image.

### II. Segmentation techniques

Segmentation techniques are used to segment the images; they are based on two basic properties discontinuity and similarity. In discontinuity approach of segmentation the image is partition or subdivided on the basis of changes in intensity level or gray level of an image. This method is mainly used for identification of isolated points, lines and edges. Similarity based segmentation approach group those pixels which are similar in some sense. It includes thresholding, region growing, region splitting and merging approaches.

### III. Classification of segmentation techniques

Segmentation can be classified into the following categories.

- i. Edge Detection
- ii. Thresholding
- iii. Region based
- iv. Feature based Clustering

#### i. Edge Detection

One of the most commonly used image segmentation technique is edge detection. An edge is the boundary between an object and the background means edges typically occur on the boundary between two regions with relatively distinct gray properties. Edge represents the discontinuity and ending. As a result of this transformation, edge image is obtained without meeting any changes in physical qualities of the input image. Edge detection is an active area of research as it facilitates higher level image analysis. There are three different types of discontinuities in the grey level like point, line and edges. Spatial masks can be used to

detect all the three types of discontinuities in an image. Edge detection techniques are generally used for finding discontinuities in gray level images. There are many edge detection techniques in the literature for image segmentation. The most commonly used discontinuity based first order derivative edge detection operators are Sobel Edge Detection, Prewitt edge detection, Roberts edge detection and second order derivative edge detection operators are Canny Edge Detection, LoG edge detection.

#### a. Sobel Edge Detection:

Sobel edge detection operator is used to detect horizontal, vertical or both edges. The mask used for sobel edge detection is,

-1	-2	-1
0	0	0
1	2	1

Horizontal

-1	0	1
-2	0	2
-1	0	1

Vertical

Sobel mask is typically used to find the approximate absolute gradient magnitude at each point in an input gray scale image. Sobel mask can handle the noise and gives an averaging effect over image.

#### b. Prewitt Edge Detection

Prewitt operator correctly estimates the magnitude and orientation of an image it is simple to implement but this operator produce somewhat nosier result. The mask for prewitt operator is as follows,

-1	-1	-1
0	0	0
1	1	1

Horizontal

-1	0	1
-1	0	1
-1	0	1

Vertical

#### c. Roberts Edge Detection

The Roberts Cross operator performs a simple, quick to compute, 2-D spatial gradient measurement on an image. Thus it highlights regions of high spatial frequency which often correspond to edges. In its most common usage, the input to the operator is a gray scale image, as is the output. Pixel values at each point in the output represent the estimated absolute magnitude of the spatial gradient of the input image at that point [2].

-1	0
0	1

Horizontal

0	-1
1	0

Vertical

#### d. Canny Edge Detection

Canny edge detection operator uses multistage algorithm to detect a wide range of edges in images. The Gaussian filter is used in canny algorithm to remove the effect of noise. Canny operator

implements three parameters as low error rate, localization and single response to a single edge.

#### e. LoG Edge Detection

The Laplacian of Gaussian (LoG) was proposed by Marr (1982). It is a second order derivative. In LoG Edge detection is smoother image and computes the Laplacian due to this it gives a double edge image. Locating edge then consist of finding the zero crossing between the double edges. The digital implementation of Laplacian operator uses the mask below,

0	-1	0
1	4	-1
0	-1	0

Horizontal & Vertical

-1	-1	-1
-1	8	-1
-1	-1	-1

Horizontal, Vertical & Diagonal

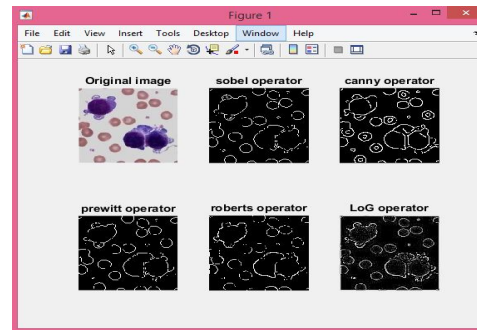

Fig.1 Edge detection techniques

#### ii. Segmentation by Thresholding

One of the most effective and simplest way of partitioning image into a foreground and background is image thresholding segmentation technique. It is most effective for the image with high level contrast. Thresholding can be implementd globally or locally.

##### a. Global thresholding

Otsu's is a global thresholding technique. In Global thresholding object and background pixel are separated by comparing with chosen threshold value. The threshold value varies over the image depending on the local characteristics of subdivided region in the image Otsu's threshold value of boundary block is used to classify objects and background in an image. The thresholding is a process of converting multilevel image into binary image containing the pixel value either 0 or 1. When the image contains nonuniform illumination global thresholding can be fail.

##### b. Adaptive thresholding

Local thresholding is also called as adaptive thresholding. To deal with nonuniform illumination multiple thresholds are used. Threshold selection is performed iteratively. Threshold value can be select automatically. In local adaptive segmentation to set threshold value maximum and minimum of mean method is used. Then by using this initial threshold



value image is segmented, as pixel within threshold follows one segment and other follows as another segment. The process is repeated until threshold value mismatch with pixel value. The threshold value is repeatedly obtain for each segment.

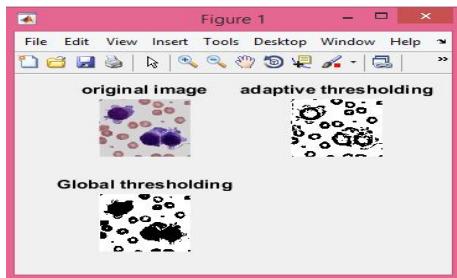

Fig.2 Segmentation by adaptive thresholding and global thresholding.

### iii. Region based segmentation

Homogeneity is the basic principal of this method, considering the fact that the neighborhood pixel inside region has similar properties and are distinct to the pixel in other regions. The main objective of this method is to form less number of regions in an image which are bigger in size and possess the similar characteristics for the entire pixels. Region based segmentation is also called as similarity based segmentation.

The simplest approach to segment image based on the similarity assumption is that every pixel is compared with its neighbor for similarity check (for gray level, texture, color, shape)[3]. If the result is positive, then the particular pixel is included in to a region and in this way the region grows. The growing is stopped when the dissimilarity found.

#### a. Single seeded Region Growing

In this technique a single seed or pixel is specified and using this all the pixels related to this seed form the region. The position of seed point is specified by user or it is randomly selected if not given. By default the maximum intensity distance 0.2 is used in this technique. The difference between pixel's intensity value and the region's mean is used as a measure of similarity.

The pixel with highest similarity measure is added into the respective region. This process stops when the intensity difference between new pixel value and region mean value becomes larger than certain threshold. Finally output image is obtained by combining both the regions. This segmentation technique is robust and faster also it is most reliable for large range of images.

### iv. Feature based Clustering

Clustering is the process of partitioning pixels into the clusters. Clusters means the group of similar pixel belongs to specific regions and different from other regions. The most widely used clustering techniques are k-means clustering and fuzzy c-means clustering.

### k-means clustering

The k-means clustering is an iterative technique used to partition an image into k clusters. In this technique initially cluster center k is selected either randomly or by using some heuristic method. Then each pixel in the image is assigned to the cluster having minimum distance between pixel and center of cluster. Again cluster center is recomputed by taking average of all the pixels in that particular cluster. This process is repeated until no pixel change occurs in cluster.

In this technique the distance is square or absolute difference between pixel and center of cluster. The difference is based on pixel intensity, texture, color and location or weighted combination of these factors. k-mean clustering method is used to perform image segmentation task for low level image.

### Conclusion:

In edge detection techniques the canny operator gives best result as compared to another edge detection operators like sobel, prewitt, Roberts and LoG. Where as in thresholding based algorithm the global thresholding and adaptive thresholding produce good results. The global thresholding technique recognizes the object very well & the adaptive thresholding produce good edges. Single seeded region growing segmentation divide the image into the different parts according to features in the image. The output of feature based k-means segmentation technique varies according to cluster size. As the cluster size is more percentage of accuracy obtained is also more.

This paper examines the performance of various segmentation techniques, using the subjective evaluation, on some microscopic images of blood smear.

The result of image segmentation technique affected by some of the factors like homogeneity of images, texture and content of image, noise present in image and spatial characteristic of image.

### References

- [1] A. M. Khan, Ravi. S "Image Segmentation Methods: A Comparative Study" IJSCE ISSN: 2231-2307, Volume-3, Issue-4, September 2013
- [2] Gonzalez, Rafael C., Richard Eugene Woods, and Steven L. Eddins, 'Digital image processing using MATLAB', Pearson Education India, 2004.
- [3] H.S. Prasantha, Dr. Shashidhara. H.L., Dr. K.N.B. Murthy and Madhavi Lata. G, "Medical Image Segmentation", (IJCSE) International Journal on Computer Science and Engineering Vol. 02, No. 04, 2010.
- [4] Vaiaprakash Gurusamy, Subbu Kanna "Review on Image Segmentation Techniques" Researchgate publication 273127438
- [5] <http://www.mathworks.com/>
- [6] [https://en.wikipedia.org/wiki/Image\\_segmentation](https://en.wikipedia.org/wiki/Image_segmentation)
- [7] Er. Pratibha Thakur, Er. Nishi Madaan "A Survey of Image Segmentation Techniques" International Journal of Research in Computer Applications and Robotics Vol.2 Issue.4, Pg.: 158-165 April 2014

## Web accessibility issues and challenges for blind Person

Miss. Vaishali A. Patil<sup>1</sup>, Prof. Harshal V. Patil<sup>2</sup>  
Assistant Professor

DOCS and IT, Bhusawal Arts, Science & P.O.Nahata Commerce College, Bhusawal

### ABSTRACT:

*This paper will discuss how to developed website using web accessibility tools which help blind person. An accessible web site is one which can be used by all its intended visitors. Inaccessible web sites can pose significant barriers to people with disabilities. The challenge of developing web content accessible by everyone has motivated the evolvment of a number of techniques to address web accessibility issues. Unfortunately, web developers often lack sufficient knowledge about these guidelines and techniques to develop accessible web sites.*

*This paper presents a survey of common web accessibility problems. Different studies and reports have been analyzed in order to summarize the most common web accessibility problems.*

*Keywords - Screen reader, JAWS, Dyslexia*

### 1. Introduction

Currently, the World Wide Web (the Web) is present in all areas of our lives. The Web has firmly entered in our everyday life and has changed our way of making shopping, managing business, accessing to e-government services, having education, enjoying entertainment, and so on. Making websites accessible for all disabled people is critical. The Web has a huge potential to transform their lives, allowing them independent access to information and services for the first time. But, if websites are badly designed and badly supported, this potential is lost and the web becomes just another arena of exclusion.

Web accessibility means that people with disabilities can use the Web. It therefore makes sense to find out whether a website really is accessible by testing it with actual users with disabilities. Accessible websites benefit everyone.

Many disabled people use additional devices (and strategies) to help them use the Web:

– Screen reader

The W3C, WAI, and WCAG is helping developers understand what they should be doing to make their websites accessible.

### 2. Objectives

- To explore new areas of career for visually challenged people.
- To explore new possibilities and fields where visually challenged people can make their career and work efficiently as well as independently.
- To improve the lives of people with disabilities (human-centered motivations)
- To capitalize on the a wider audience or consumer base (marketing or economic-centered motivations)
- To avoid lawsuits and/or bad press (public relations and punishment-centered motivations)

### 3. Web Accessibility Issues for blind person:

For those unfamiliar with accessibility issues pertaining to Web page design, consider that many users may be operating in contexts very different from your own:

- They may not be able to see, hear, move, or may not be able to process some types of information easily or at all.
- They may have difficulty reading or comprehending text.
- They may not have or be able to use a keyboard or mouse.
- They may have a text-only screen, a small screen, or a slow Internet connection.
- They may not speak or understand fluently the language in which the document is written.
- They may be in a situation where their eyes, ears, or hands are busy or interfered with (e.g., driving to work, working in a loud environment, etc.).
- They may have an early version of a browser, a different browser entirely, a voice browser, or a different operating system.

### 4. Web Accessibility Tools

---

Many web designers, developers, and evaluators are introduced to web access through accessibility tools. All accessibility tools perform automated checks of web pages for accessibility issues and all generally have additional features, but each tool targets different audiences. In order to help web designers, developers, and evaluators choose an appropriate tool for their purposes.

However, web accessibility requires more than just accessibility tools; it requires human judgment. It is important to remember that accessibility tools can only partially check accessibility through automation. The real key is to learn and understand the web accessibility standards rather than relying on a tool to determine if a page is accessible or not.

### Screen reader

Screen readers are applications that visually-impaired users employ to assist them in navigating websites and applications. These applications read out text and navigation items using a synthesized voice. To truly understand the experience you need to install a reader such as JAWS, and attempt to navigate your application with your monitor turned off.

### Using JAWS to Evaluate Web Accessibility:

JAWS (Job Access With Speech) is a computer screen reader program for Microsoft Windows that allows blind and visually impaired users to read the screen either with a text-to-speech. While working in JAWS, keep the following guidelines in mind:

- While JAWS can be used for accessing Windows and most Windows applications, we will be focusing on accessing web content only.
- Make sure that NumLock is off.
- You will probably want to test JAWS in Internet Explorer, even if it is not your primary browser.
- Maximize the browser window.
- Remember that screen reader users typically do not use a mouse. As you become more comfortable with JAWS, try using only the keyboard.
- Keep in mind that most IE shortcut keys will work when using JAWS.
- The page *may not* scroll while you read, so you may hear content being read by JAWS that isn't visible on the screen.

## 5. Commitment and accountability of Web Accessibility

**Awareness:** The foundation of any kind of commitment to web accessibility is awareness of the issues. Most web developers are not opposed to the concept of making the internet accessible to people with disabilities. Most accessibility errors on web sites are the result of lack of awareness, rather than malice or apathy.

**Leadership:** Understanding the issues is an important first step, but it does not solve the problem, especially in large organizations. If the leadership of an organization does not express

commitment to web accessibility, chances are low that the organization's web content will be accessible. Oftentimes, a handful of developers make their own content accessible while the majority doesn't bother to, since it is not expected of them.

**Policies and Procedures:** Even when leaders express their commitment to an idea, if the idea is not backed up by policy, the idea tends to get lost among the day-to-day routines. The best approach for a large organization is to create an internal policy that outlines specific standards, procedures, and methods for monitoring compliance.

## 6. Laws and standards

Applicable laws include ADA, IDEA, and the Rehabilitation Act of 1973 (Sections 504 and Section 508). Many international laws also address accessibility.

The Web Content Accessibility Guidelines provide an international set of guidelines. They are developed by the Worldwide Web Consortium (W3C), the governing body of the web. These guidelines are the basis of most web accessibility law in the world. Version 2.0 of these guidelines, published in December 2008, is based on four principles:

- **Perceivable:** Available to the senses (vision and hearing primarily) either through the browser or through assistive technologies (e.g. screen readers, screen enlargers, etc.)
- **Operable:** Users can interact with all controls and interactive elements using the mouse, keyboard, or an assistive device.
- **Understandable:** Content is clear and limits confusion and ambiguity.
- **Robust:** A wide range of technologies (including old and new user agents and assistive technologies) can access the content.

The disabilities that are most likely to affect your users fall into four major categories and present their own challenges for developers:

### Visual Impairment

Visual impairment includes tunnel vision, color blindness, and, of course, being legally blind. Visually impaired users are often the most affected when it comes to accessibility issues, since everything done on a computer is to some extent visual. These users rely heavily on the keyboard for input and control, and tend to avoid using a mouse. A screen magnifier or screen reader provides a lot of assistance, as do audio events and cues. Some use a Braille display to "read" the text on screen with their fingertips.

### Dyslexia

Dyslexic users are likely to have great difficulty reading a web page or dealing with large amounts of textual controls. In some cases this can extend to difficulty with data entry too, such as using a search function. Strategies such as logical page or screen structure can help, as well as developers adopting design philosophies that make an application as self-

explanatory as possible. Dyslexic users may also use screen readers to aid with their comprehension.

### Motor Disabilities

Motor disabilities can range from hand or arm tremors, a loss of limbs, or a lack of control and movement of body parts. In these cases input devices need to be considered, bearing in mind that users may be entirely unable to operate a mouse. Even if the user is unable to type, other assistive technologies exist to help them. Full keyboard navigation and control is essential for these users.

### Cognitive Disabilities

This group is probably the farthest reaching. Disabilities may include faculty impairment such as memory recall, comprehension, and interpretation. In some cases these can be temporary situations; in others they're permanent and there's no easy solution to cater for them all. This group is best served by a combination of techniques used for the other three groups, tied to an overall design philosophy aware that more and more people on the Web are not geeks or programmers, and so approach software differently from the way we expect.

## 7. Key principles of accessible design

Most accessibility principles can be implemented very easily and will not impact the overall "look and feel" of your web site.

- Provide appropriate alternative text
  - Alternative text is a textual alternative to non-text content, usually images in web pages.
- Make sure that content is well structured and clearly written
  - Write clearly, use clear fonts, and use headings and lists appropriately.
  - Organize your content using true headings (heading 1, heading 2, etc.).
- Help users skip to relevant content
  - In a web page, provide a link that allows the user to skip from navigation to the main content in the page.
  - Provide a table of contents with links to each sub-section
- Provide headers for data tables
  - Tables that are used to organize tabular data should have appropriate table headers. Data cells should be associated with their appropriate headers.
- Ensure users can complete and submit all forms
  - Ensure that every form element (text field, checkbox, dropdown list, etc.) has a label and make sure that label is associated to the correct form element using the <label> tag. Also make sure the user can submit the form and recover from any errors, such as the failure to fill in all required fields
- Ensure links make sense out of context
  - Every link should make sense if the link text is read by itself. Certain phrases like "click here" and "more" must be avoided
- Caption and/or provide transcripts for media

- Videos and live audio must have captions and a transcript. With archived audio, a transcription may be sufficient.
- Do not rely on color alone to convey meaning
  - The use of color can enhance comprehension, but do not use color alone to convey information. Make sure that color contrast is strong.
- Design to standards
- HTML compliant and accessible pages are more robust and provide better search engine optimization. Cascading Style Sheets (CSS) allow you to separate content from presentation. This provides more flexibility and accessibility of your content.

## 8. Experiment of accessible design

With respect to enhancing website accessibility for people with various degrees of visual impairments inclusion of website accessibility features such as the following are being identified and implemented. Some of the most common eye disorders such as Retinopathy, Glaucoma, Cataract and Retinitis Pigmentosa in which the strength of the vision gradually deteriorates, the contrast sensitivity of the eye is greatly affected causing insensitivity to different levels of brightness and similar shades. To help such persons with low vision, a second version of the college website with greater contrast is being considered for design.

The webpage's are being recorded with semantically meaningful HTML so that the visually challenged can have easier maneuverability and navigability across the webpage's using the text to speech software. The measures include providing textual description for images, easy to understand descriptions to links, etc. Keeping the webpage viewers with low vision in mind, the facility to scale the images and view them enlarged is also being incorporated. The webpage's are being redesigned using alternate style sheets with regular and larger font sizes, ensuring the layout of the pages is not compromised when text-only zoom is enabled in the browser. In case of webpage's where a lot of description is present, text only versions are also being offered so that such text can be manipulated suiting the requirement of the user. For people with color vision deficiency, use of red and green colors is minimized as far as possible. A lot of standard keyboard shortcuts are also incorporated into the webpage's ensuring easier navigation with keyboard and reducing the use of mouse cursor.

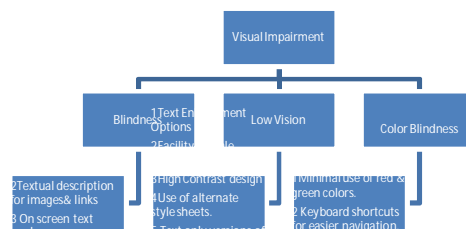

Figure 2: Different Kinds

It is also realized that the use of college website can be greatly enhanced if the website is made available in other languages. Using the Google's free online language translation service that instantly translates text and web pages, language translation plug-in tool is added to all the webpage's of the college website. Thanks to Google Translate, now the college website is available in over 60 languages, of which six are Indian languages.

## 9. Conclusion

The web offers so many opportunities to people with disabilities that are unavailable through any other medium. It offers independence and freedom. However, if a web site is not created with web accessibility in mind, it may exclude a segment of the population that stands to gain the most from the internet. Most people do not intend to exclude people with disabilities. As organizations and designers become aware of and implement accessibility, they will ensure that their content can be accessed by a broader population.

This conclusion can be drawn from the review of literature where several groups within academe, that should be aware of accessibility issues, maintained Web sites with low levels of accessibility.

## 10. References

This material was adapted from the following Web sites:

- <http://www.w3.org/WAI/eval/users.html>
- <http://www.microsoft.com/enable/guides/vision.aspx>
- <http://developer.gnome.org/projects/gap/at-types.html>
- <http://webaim.org/articles>
- <https://validator.w3.org/>
- <http://ncdae.org/tools/factsheets/principles.cfm>

## An overview of different Steganography and Image Steganography techniques.

**Mr. Rakesh KishorRane.**<sup>[1]</sup>  
<sup>[1]</sup> Assistant Professor, KCES's Institute of Management and Research, Jalgaon

**Dr.Bhojraj H. Barhate.**<sup>[2]</sup>  
<sup>[2]</sup> Vice Principal, TES's Bhusawal Arts, Science and P. O. Nahata Commerce College, Bhusawal

### ABSTRACT:

Now a days, Digital communication takes place frequently on the internet and applications. Hence, The Security becomes important and must be provided. The formation of a secure communication between sender and receiver is becoming a difficult problem due to the possibility of attacks and other unpremeditated changes during dynamic communication over an unsecured network. However, the secrecy of information can be secured using steganography". Steganography refers to the act of covering a message (without any traceability) in such a manner that it will make no sense to anyone else except the intended recipient. Steganography masks the existence of a secret message. In this paper, the aim is to analyze different ways of steganographic techniques used to achieve Steganography on the basis of digital media used for steganography and Some of the popular image steganographic techniques which are used commonly while masking secret message in an image

**Keywords:** UDP,TCP/IP,SCTP.

### I. INTRODUCTION

#### Steganography:

Steganography, is term which means 'Writing in Hiding'. Steganography is art of hiding confidential information in a cover media like image, audio, video in such a way that the attackers will not be able to detect it [1] (Figure- A generic Steganography System). The applications of information hiding systems mainly range over a broad area from military, intelligence service, internet banking, medical science and so many others. These variety of applications make steganography important. The cover medium is always chosen by considering the type and the size of the secret message and many different file formats can be used for carrier. In the current situation digital images are the most popular carrier/cover files that can be used to transmit secret information [2]. Before inserting an information in a cover media, the sender party must first convert the confidential message, then manipulate some of the bits

of the cover object to form the stego-object [1]. Then, the stego-object is transmitted over a communication medium to the receiver. When receiver receives, the process is performed in a reverse manner and extract the hidden information is extracted from stego-object. If the process involves a secret key, both parties (sender and receiver) must have the key prior to the transmission of the stego-object [4]. The following figure illustrates that, How the general steganographic system works?

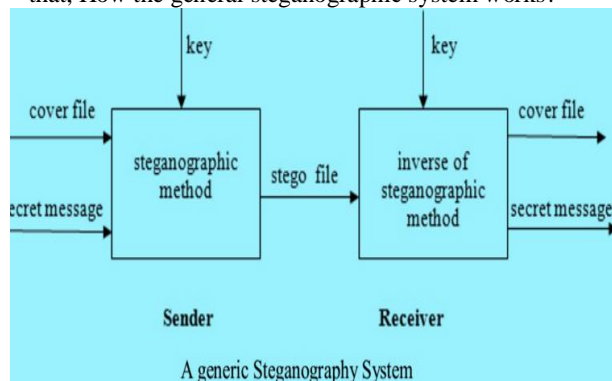

The general terms used in figure and commonly used with steganography are explained below as in [5] [6]:

**Secret Message:** The secret information or data to hidden.

**Cover File/ Digital Medium:** The digital medium which masked the secret message.

**Stego File:** A modified version of cover file / digital medium that comprises the secret message.

**Key:** Additional secret data/number that is used while embedding the message and will also be required and used in the process of extraction and must be known to both the parties, the sender and the receiver. *Key is optional Pure Steganography.*

**Steganographic Method:** It is function that produces stegoas output by making use of medium, secret data and key as parameters.

**Inverse of Steganographic Method:** This is the inverse of the Steganographic method used in embedding/masking process.

---

### ▪ **Features of Steganographic System :**

Any operational steganographic system should possess the following characteristics as in [6]:

**Secrecy/Irreversibility:** An intender should not be able to extract the hidden information from the stego object without the knowledge of the secret key used in the embedding process.

**Imperceptibility:** The cover file / object after being embedded with the hidden information should be imperceptible from the original. One should not become doubtful of the presence of the covered data within the cover object.

**High capacity:** The length of the covert message that can be masked should be as lengthy as possible.

**Resistance:** Even if the cover medium or file has been manipulated for example by any lossy / lossless compression technique, the secret data should be able to persist as it is.

**Accurate extraction:** The extraction of the secret data embedded from the cover medium should be exact and reliable.

### ▪ **Classification of Steganography**

#### **On the basis of type of protocol used in while implementing steganography System:**

Protocol is the set of rules, that has to be followed by both the parties. These set of rules are same at both the ends, sender side and receiver side. There are basically three types [5] of steganographic protocols used. They are -

**Pure Steganography:** It is a steganographic system which does not need the exchange of a stego-key. This method of steganography is not considerably secure because both the parties can trust only upon the notion that intruder is not aware of the secret information.

**Secret Key Steganography:** It is a steganographic system which makes use of secret key (stego key) on sender side while masking the secret message in cover medium. And key requires to be exchanged as on the receiver side it is required to extract the original secret message. The parties who is aware of the secret key, can only extract and read the secret message hidden in cover medium. Secret Key Steganography exchanges a secret/stego-key, which makes it more vulnerable to intercept. One advantage of this steganography is even if intruder intercepts that the secret message is hidden; intruder is required to have knowledge of secret key to extract the secret message.

**Public Key Steganography:** This system makes use of two keys; a public key and a private key for better security. Public key and Private key has some mathematical relationship among them. Sender uses the public key during the embedding process and only the associated private key can decrypt the secret message.

#### **On the basis of type of cover medium or object:**

There are five different types of cover medium / objects which are used in Steganography when masking secret information. They are audio, video, text, protocol and image. Depending upon the type of the

cover medium used the Steganography techniques were classified and defined in [7] [8] as:

**Audio Steganography:** In this type of steganography, audio signal is used as cover medium hence it is called as "Audio Steganography". In this technique the different audio formats such as .mp3, .wav etc. can be used as cover medium to hide secret message.

**Video Steganography:** In this type of steganography, video signal is used as cover medium hence it is called as "Video Steganography". Videos is nothing but the collection of images and sounds. Because of which one can mask large amount of data. Generally, MP4, MPEG, AVI, or any other video formats are used as cover medium to hide the secret message.

**Text Steganography:** In this type of steganography, texts are used as cover medium, hence it is called as "Text Steganography". General techniques to hide the secret message are- the number of white spaces, tabs, capital letters and every word's  $n^{\text{th}}$  letter can be used in the process of embedding the secret message.

**IP ("Internet Protocol") Steganography:** In this type of steganography, the protocol followed by network protocol such as TCP/IP (Transmission Control Protocol), Stream Control Transmission Protocol (SCTP), User Data Protocol (UDP), etc. were used for cover object. The Steganography can be done in unused header bits of TCP/IP.

**Image Steganography:** In this type of steganography, image is used as cover medium, hence it is called as "Image Steganography". Generally, Sender uses the intensity of pixels in the process of masking in this technique.

*Steganalysis: Statistical steganalysis is the practice of detecting hidden information by applying statistical tests on image data.*

The two other techniques that are related to steganography are Watermarking and fingerprinting but they are not in the same class [1].

#### ▪ **Image Steganography Techniques [8]:**

Image steganography refers to hiding information i.e. text, images or audio files in another image or video files. The current project aims to use steganography for in image with another image using spatial domain technique. One can retrieve this hidden information via only proper decoding technique. The image steganography techniques are divided into two categories.

#### **Transform Domain based Image Steganography:**

In this technique, in the beginning the cover-image is transformed into its frequency domain. Later on the the secret message is hidden in the coefficients frequency. The benefit of this technique: more robust against simple and statistical attacks but its payload capacity is very less.

---

## Spatial Domain based Image Steganography:

In Spatial Domain based Image Steganography technique, the pixel intensity is in the process of embedding secret message. Benefits of this techniques are: Its payload capacity is high, easy to implement and hidden data is not perceptible. But the drawback of this technique is its vulnerability, is it can be easily broken by simple statistical attacking methods. The common spatial domain Image Steganography techniques are:

- Least significant bit substitution method (LSB)
- Random pixel embedding method (RPE)
- LSB Matching Technique
- Colour component based method
- SLSB Technique
- Pixel value differencing (PVD) method
- Edges based data embedding method (EBE)
- Pixel indicator based method
- Pixel Intensity based method
- Palette based technique
- GLM (Gray level modification) technique
- BPCS method
- Patchwork method

### LSB substitution Technique:

In this technique, LSB of image pixel is substituted sequentially with message bit.

Eg. **10101011** message stream

Image pixels are.....

**10101111 10101011 11111111 10101010**

**101010101 11111110 11010101 11001100**

New image pixels after inserting message stream

**10101111 10101010 11111111 10101010**

**101010101 11111110 11010101 11001101**

This steganography method is less complex to implement but its less payload capacity is very less. A only one bit of message embedded in every pixel and this technique is less robust as secret message bits are added sequentially in the bits of the image pixel so easily predictable to the intruder.

To advance robustness, new LSB based image steganography techniques are innovated in which the message bits is not embedded sequentially in the image pixels. Instead of this, the cover image is divided into the blocks of fixed size and the bits of secret message are embedded in each block.

### Random Pixel Embedding Technique (RPE)

Unlike LSB technique, in the RPE technique does not embed the bits of secret message sequentially, in this steganography technique the bits are embedded at random position which increases robustness of steganography against attack. For embedding it uses last two bits of each random position pixel.

### LSB Matching Technique

Unlike LSB substitution in which LSB of the image pixel is replaced with the bit of secret message, in this steganography technique the secret message bits are

embedded into cover image by adding -1 or 0 or 1 to pixel of cover image.

### Colour Component Based Technique

In this steganography technique the algorithm "colour cycle" is used. This algorithm makes use of all the three colours for embedding data. At max 4 bits can be added per colour and all colours are treated similarly. A message bits are embedded sequentially into the image pixel. This technique is less robust against statistical attacks, as it uses or treats all three colours of the pixel equally for hiding the secret bits.

### SLSB (Selective LSB) Technique

In this steganography technique, all the colour components of pixel are not used for hiding the bits of secret message, but it uses sample pair analysis. Only one colour component is selected for embedding the bits of secret data and later on LSB matching technique is used after the process of embedding secret data. It reduces the distance of colour between stego colour and original colour.

### Pixel Value Differencing (PVD) Technique

In this steganography method, first difference between two non-overlapping and neighbourhood pixels is calculated, then based on the calculated difference value, whether the pixel belongs to edge or smooth area is decided. The number of bits embedded per pixel is decided on the basis of the difference value. The secret message bits are hidden into edge pixels and then non-edge pixels. But these methods can be useful in case of gray scale image only.

In case of RGB colour image, bi-directional Pixel Value Differencing method is used. In this differencing method, the difference between two pixels is calculated at both the side, this improves not only payload capacity but also it improves security of message.

### Edge based Data Embedding Technique

In this steganography technique, by using canny edge detection technique edge pixels are found and then in the 3 LSBs of each colour channel of edge pixels only the secret data are stored. The edge area of any image can tolerate more changes than the smooth area of an image. It increases robustness. But as non-edge area pixels are not used for hiding the data causes less payload capacity.

### Pixel Indicator Technique

We know that there are three colour channels in an image. In this steganography technique out of 3 colour channels 1 colour channel is referred as indicator channel and remaining 2 channels are used as data channel. An indicator channel is used to indicate, whether data bits are embedded in both of data channels or not. In this technique image is divided into number of blocks. For every block, indicator channel is decided. The colour whose total value in particular block is maximum becomes indicator channel. To improve robustness same indicator channel is not used for all the pixels. But the image first divided into 4 sub images



---

then either default (i.e. red colour) or user defined pixel is used as an indicator channel in zig zag manner.

### **Pixel Intensity based Technique:**

In this steganography technique is useful for colour image. In this, out of 3 colour channels two channels used to store secret message and remaining one channel is used as an indicator channel. To increase robustness, in this technique any channel is used as indicator channel and sequence is not maintained. Number of bits depending upon colour intensity are added, if intensity is more, then less number of bits are added and vice versa.

### **Palette based Technique**

This technique of steganography is only for images that are in GIF or PNG format and with 256 colours at max. In palette based technique, secret message bits are not directly embedded to the pixel of an image, but palette table of an image is used for embedding the data bits. By quantizing two same colours say a and b, new colour is created and then new colour entry assigned by binary choice 0 or 1 for the selection of colour a and b. This reduces image distortion after embedding the data bits. The Payload capacity is low in this technique.

### **Gray Level Modification (GLM) Technique**

This is a simplest technique of steganography. In the gray level modification technique, gray level values of the image pixels are modified to map the secret data.

### **BPCS Technique**

In this technique, the image divided into number of bit-planes. Then it replaces complex regions of every bit-plane with random binary pattern. For region segmentation, it uses B-W border based complexity measure.

### **Patchwork Technique**

In patchwork technique of steganography, as proposed by the researchers, a statistical approach is used for hiding the secret data. In this technique two patches say X and Y are chosen randomly. All the pixels of X-Patch are lightened and all the pixels of Y-Patch are darkened. By using a constant value, the intensity of the pixels in the one patch is increased and in another patch decreased. This patchwork technique of steganography is more robust against image manipulation, because two copies of secret data are stored in an image.

### **Separable Reversible Data Hiding Technique (SRDH)**

In this data hiding technique, two keys are used. One is encryption key and another is data hiding key. First by using encryption key the image is encrypted then by using data hiding key image is compressed to embed secret data bits. For embedding secret data, four positions are randomly selected (5, 6, 7, and 8) and pixel are used. In this technique secret data embedded in the image in lossless manner. So that the image can be extracted as it is without any distortion which may occurs in other techniques due to data embedding. The data can be extracted from an encrypted image separately without decryption of an image. Both the processes, one of extraction of image and another of extraction of data can be separate at receiver side.

### **Conclusion:**

This paper reviewed the different steganographic techniques based on protocol and medium used to mask the secret data. Different image steganography techniques are also reviewed which covers different techniques for hiding information in image files of type .jpeg, .png, .gif. It also covers pros and cons of these techniques. Each of these techniques tries to satisfy the three most important factors of steganographic design (imperceptibility or undetectability, payload capacity, and robustness).

### **References:**

- [1] M. Chaudhari and S. Patel, "A survey on cryptographic algorithm," *IJASCSMS*, vol. 2, no. 3, pp. 100-104, 2014.
- [2] S. Mishra, V. K. Yadav, M. C. Trivedi and T. Shrimli, "Audio Steganography Techniques: A Survey In Advances in Computer and Computational Sciences," in *Springer*, Singapore, 2018.
- [3] M. Sahu, S. R. Pradhan and M. Das, "Unicode and Colours Mapping for Cryptography and Steganography using Discrete Wavelet Transform," *International Journal of Computer Applications (0975 – 8887)*, pp. 34-41, May 2013.
- [4] G. Umamaheswari, C. P. Sumathi and T. Santanam, "A Study of Various Steganographic Techniques Used for Information Hiding," *IJCSES*, vol. 4, no. 6, pp. 09-25, 2013.
- [5] Sheelu and B. Ahuja, "An Overview of Steganography," *IOSR-JCE*, vol. 11, no. 1, pp. 15-19, 2013.
- [6] F. G. Petitcolas, R. J. Anderson and M. G. Kuhn, "Information hiding-a survey," *IEEE*, vol. 87, no. 7, pp. 1062-1078, 1999.
- [7] A. Mohammed, A. H. Fadhil and D. Mohammed, "Image Steganography Technique Based on Extracted Chains from the Secret Key," *Journal of Engineering and Applied Sciences*, vol. 13, no. 11, pp. 4235-4244, 2018.
- [8] S. N. KISHOR, D. G. N. KODANDA and D. S. A. JILANI, "A REVIEW ON STEGANOGRAPHY THROUGH MULTIMEDIA," *ICRAINS*, 2016.
- [9] K. P. Adhiya and S. A. Patil, "Hiding Text in Audio Using LSB Based Steganography," *Information and Knowledge Management*, vol. 2, no. 3, 2012.
- [10] A. Acar, A. Hidayet and S. A. ULUGAC, "A Survey on Homomorphic Encryption Schemes: Theory and Implementation," *ACM Computing Surveys (CSUR)*, vol. 51, no. 4, p. 79, 2018.
- [11] V. and D. R. S. Chhillar, "Data Hiding Using Steganography and Cryptography," *International Journal of Computer Science and Mobile Computing*, vol. 4, no. 4, pp. 802-805, 2015

## Data Mining Techniques and Applications

**Ankita Sanjay Deo**  
Department of Computer  
Management, Systel Institute of  
Management and Research, Dhule  
Maharashtra, India  
[0607deoankita@gmail.com](mailto:0607deoankita@gmail.com)

**Divya Deepak Joshi**  
Department of Computer  
Management, Systel Institute of  
Management and Research, Dhule  
Maharashtra, India  
[divyajoshi448@gmail.com](mailto:divyajoshi448@gmail.com)

**Hansraj M. Patil**  
Department of Computer  
Management, Systel Institute of  
Management and Research, Dhule  
Maharashtra, India  
[hmpatil.systel@gmail.com](mailto:hmpatil.systel@gmail.com)

### ABSTRACT:

Data mining is a process used by companies to convert raw data into useful information. Data mining is used to search large stores of data, to find patterns and trends that go beyond simple analysis. Data mining is also known as Knowledge Discovery Database (KDD). It is the process which comprises extracting interesting, interpretable and useful information from the raw data. There are different sources that generate raw data in very large amount such as multimedia data, relational data, data warehouse, flat file etc. Data mining technique organizations can use to turn raw data into actionable insights. In literature many data mining techniques are available but few of them are studied in this article, such as classification, statistics, neural network, decision tree, association etc. Data mining technique has to be selected based on the type of business and the type of problem your business faces. A generalized approach has to be used to enhance the accuracy and cost-effectiveness of using data mining techniques. Data mining is proved to be an important tool in many areas of business and the techniques are best used in deriving solution to a problem. Therefore it is very crucial for companies to use data mining techniques to help the businesspeople to make smart decisions.

**Keywords:** Data Mining Techniques (DMT), Knowledge Discovery Database (KDD), Data mining Applications

### 1. Overview of Data Mining:

The development of Information Technology has generated large amount of databases and huge data in different areas. Data mining is the process of examine data and encapsulate it to produce useful information. Data mining tools allow a business organization to estimate customer behavior. Data Mining is also called as Knowledge Discovery in Database (KDD) process. KDD is the process of required output extraction in various types of formats from raw data. KDD is also defined as the process to view useful patterns in data. A KDD process as shown in fig. 1.

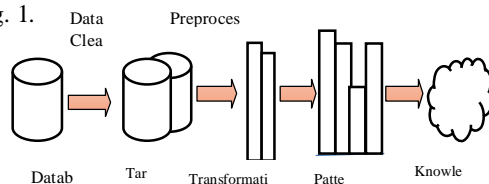

**Fig. 1. KDD Process**

### 1.1 Data Mining Tasks:

Data mining process is categorized into two task i.e. Descriptive Task and Predictive Task

**I) Descriptive Task:** It identifies, what can happened in the part by analyzing stored data. We find patterns that describe the data.

**II) Predictive Task:** It describe what can happen in the further with the help to past data analysis. Use some variable to predict unknown or further values of other variable. In simply, I try to find value of an attribute so you often attribute using the value of other attributes.

### 2. Data Mining Techniques:

Data mining techniques (DMT) are used to convert raw data to useful knowledge. Various data mining techniques are used for knowledge discovery from databases. The goal of this technique is to discover patterns that were earlier unknown. Once these patterns are establish they can further be used to make precise decisions for growth of their businesses. In this paper different DMT are explained.

### 2.1 Classification

Classification is a predictive data mining technique. Classification categorizing a given set of data into classes, it can be performed on both structured and unstructured data. The process starts with predicting the class of given data points. The classes are frequently referred to as target, label or categories. Classification is the systematic approach to build classification model from input data.

The data classification process involves learning phase and classification phase.

- i) In learning the training data are analyzed by classification algorithm.
- ii) In classification test data are used to estimate the accuracy of the classification rules.

Classification makes use of mathematical techniques such as decision tree, statistics, Neural Network etc.

---

### 2.1.1 Decision tree:

A decision tree is a predictive model and the name itself implies that it looks like a tree. It typically start with a single node. Which branches into possible outcomes. Each of these outcomes leads to additional nodes, which branch off into other possibilities. They can be used to understand non-linearly and map out an algorithm that predict the best choice mathematically. The decision tree algorithm builds the classification model in the form of a tree structure. It provides results that can be easily understood by the user. It is frequently used by statisticians to find out which database is more related to the problem of the business. It can be used for Prediction and data pre-processing.

### 2.1.2 Statistics:

DMT statistics is a branch of mathematics which coordinate with collection and description of data. Statistical techniques are at the basic of most analytics involved in the data mining process. It helps to find the patterns and build predictive models. Data analyst should have some knowledge about the different statistical techniques. There are different forms of statistics but the most important and useful technique is the collection of data. There are a lot of method to collect data such as mean, median, mode, max, min, variance, histogram etc. One example of utilize statistics is measuring the number of visits. If data construct a relational database, then SQL provide numerous functions like mode and sample size. All the techniques transform large data into specific visual display. Frequently, large data are described as graphs, charts and 3D representations. These visualized data can be around exams, courses, assignments. Instructors can get information about their students and distance classes.

### 2.1.3 Neural Network:

Neural Network are very strong predictive modeling technique. It consists of neurons that are arranged in layers, they take some input vector and transform it into output. The process involves each neuron taking input and applying a function which is often a non-linear function to it and then passes the output to the next layer. The neural network system is modeled like a human brain. The human brain consists of millions of interconnected neurons. In a similar way, the neural network is an interconnection of artificial neurons and each connection has associated weight. By adjusting the weights, due to its adaptive nature it helps in minimizing the error. These neurons work together in parallel to produce the output function. They are computational model that are helpful in the field of computer science and many other research fields. For example handwritten character reorganization, for training a computer to pronounce English text and many real world industrial problems and have already been successfully applied in many industries. Neural Networks are best at

recognize patterns in data and applicable for prediction or forecasting needs.

### 2.2 Association Rule

Association rules technique is a well-liked and well researched method to finding interesting relations between variables in huge amount of database. In data mining association rules are convenient for analyzing and predicting the customer behavior. Association rules or if-then statements that aid to expose the relationship between unrelated data in a relational database or other information repository. An example of the association rules would be if a customer buys a bread he's 80 percentages likely to purchase butter also. It expressed how items or objects are related to each other and how they tend to group together. Consider another example in a super market if a customer buys onions and potatoes together he is likely to buy tomatoes also. Such information can be used as a basis for marketing activities such as product promotion or product pricing. As we seen earlier example If a person get bread his likely to get butter also with some percentages like 20% and 45%, what it is 20% is support and 45% is confidence will see in detail . Bread is antecedent, Butter is consequent, 20% is support and 45% is confidence. Support and confidence are two popular measurements  $A \Rightarrow B$ , Support denotes probability that contains both A & B and Confidence denotes probability that a transaction containing A also contain B. Consider an example, looking for people purchasing bread, total number of transaction in a supermarket is 100 out of 100 transaction at a supermarket in 20% people are purchasing bread so  $20/100 \times 100 = 20\%$  which is support. The 9 transaction out of 20 transaction, people who or getting bread also gets butter, so  $9/20 \times 100 = 45\%$  which is confidence.

There are three types of association rule. Are as:

- Multilevel Association rule
- Multidimensional Rule
- Quantitative Association Rule

### 3. Data Mining in Healthcare Application

The treatment, management and prevention of illness and the preservation of the physical and mental well-being of a person with the help of medical and associated health professionals. The aim for a healthcare system, according to the world health organization are to ensure the good health and respond to the expectations of the population as well as fair financial aid from the people and the government.

Healthcare industry today generates huge amounts of complex data about patients, hospital resources, disease diagnosis, electronic patient medical records, medical devices etc. That can make some problems such as: avoidable harm to patients, too much unnecessary care, lack of transparency, billions of dollars are being wasted etc.

---

## How Data Mining works?

The large amounts of data are a key resource to be processed and analyzed for knowledge extraction that enables support for cost-savings and decision making. Data miners mostly use the cross-industry standard process for data mining [CRISP-DM] to study the data. The process involves six steps:

- i. **Business Understanding:** Identify the project's objectives and requirements from a business perspective and define the data mining problem.
- ii. **Data Understanding:** Collection the initial data, become familiar with it, and look for any data quality problems.
- iii. **Data Preparation:** build the final dataset from raw data.
- iv. **Modeling:** Use data mining software to analyze
- v. **Evaluation:** evaluates the achievement of the project's objectives by comparing data mining models and their results using a common yardstick
- vi. **Deployment:** Implement the data mining results

### 4. Conclusion:

Data is the basic entity in every field needs to be managed in efficient way. Data mining helps a lot in this regard. It also helps in securing and processing the data into understandable cube. In this paper explains various data mining techniques like classification, Decision tree, Neural Network, Statistics, and Association rule etc. helps in finding

the patterns to decide upon the future trends in business to develop. Classification mining helps to identification of organism. Classification technique is used to obtain important and relevant information about data. Association rule mining is given which is the process of finding co-relations, frequent patterns, and association or causal structures among sets of

items in the transaction database or other repositories. Finally this paper explains the application of data mining in healthcare. Developing efficient data mining tools for an application could reduce the cost and time constraint in terms of human resources and expertise. This paper simply generalizes the concept, techniques and application of data mining.

### References:

1. Hussain Ahmad Madni, "Data Mining Techniques and Applications-A Decade Review", 2017
2. Ameera M. Almasoud, "Recent Developments in Data Mining Applications and Techniques", The tenth ICDIM 2015
3. Subhash Chandra Pandey, "Data mining Techniques for Medical Data: A Review", International conference on (SCOPE)-2016
4. Bharati M. Ramageri, "Data Mining Techniques and Applications", Indian Journal of Computer Science and Engineering Vol.1 No. 4301-305
5. <https://youtube.be/RiFrbyiYpRs>
6. <https://youtu.be/pXdum128xww>
7. <https://www.educba.com/data-mining-techniques/>

## Conceptual Design Approach of Active Stream Data Warehouses

**V P Mahajan<sup>#1</sup>,**  
*<sup>1</sup>Asstt. Prof. Smt. G.G. Khadse College, Muktainagar Dist. Jalgaon (MH)-India. vpmahajan19@gmail.com*

**Dr. B H Barhate<sup>#2</sup>**  
*<sup>2</sup>Vice Principal & Head DOCS, Bhusaval Arts, Science and P.O. Nahata Commerce College Bhusaval (MH)-India barhate\_1@yahoo.com*

**ABSTRACT:**

*The innovation technology of data warehouses and attentive systems become progressively sophisticated for effective and efficient data management and Decision Support Systems (DSS) tools. In this paper, introduce the view of Active Stream Data Warehouse (ASDW) and proposes of UML profile modeling Active Stream Data Warehouses. Integrity Constraints for Spatial Online Analytical Processing (ICSOLAP) profile is allow continuous and window OLAP queries. Data stream management systems (DSMSs) to manage continuous data streams. Also, considers stream and OLAP dynamic procedure and set of Event-Condition-Action (ECA) rules to consequently trigger OLAP administrators.*

**Keywords:** ASDW, Data Warehouse, Stream Data, ICSOLAP, UML Profile, DSMSs, ECA

### I. INTRODUCTION

A data warehouse stores large volume of purify data which extracted from operational sources and transformed into required format for further analysis [3]. The assortment and large number of accessible information and Decision Support Systems (DSSs) can make it hard to distinguish the correct answer for applications. Active data warehouse is central repositories of various types of transactional data. An active data warehouse (ADW) is used for future decision making accomplishment which locates near-time or near-real-time, it is designate by event-driven performances [6]. An active database occurring an event triggers which is predefined processing related to that triggering-event. This work relates Data warehouses (DWs), stream data and On-Line Analytical Processing (OLAP) tools to enhance technologies to support decision making system [2]. The conceptual design of Business intelligence (BI) systems seems more useful and allow users to particular focus on functional requirements excluding technological issues [1]. Through the introduction of analysis rules, an active data warehouse allows for fact-based management of business processes [4-5].

### II. UPDATES IN ACTIVE PROCESSING OF DATA

In the database field leading to active databases occurring of an event triggers a predefined processing associated to that triggering-event. The active conduct is normally indicated as far as Event-Condition-Action (ECA) rules [7]. An active warehouse is revived online and attains a higher stability between the stored information and the new data updates. The Data Warehouses and OLAP systems permits analysis of large amounts of data modeled as per the multidimensional model Warehouse data are stored as fact and dimension tables.

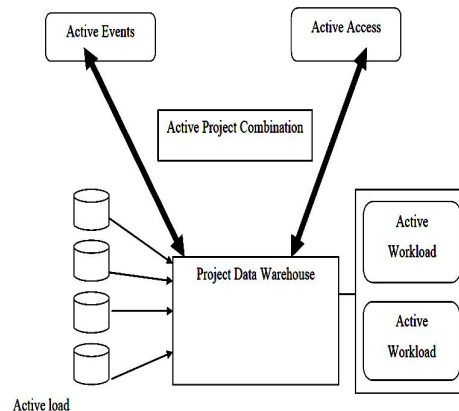

**Fig.1 Element of Active Data Warehouse**  
 Courtesy by :Shodhgangashodhganga.inflibnet.ac.in bitstream 09chapter 1

Data stream management systems (DSMS) have been developed to provide real-time analysis and to generate alerts. Fig. 1 shows Active Data Warehouses (ADWs) are inspired from active databases that are based on the ECA active rules (Event-Condition-Action). The ADWs' objective is to allow them to react automatically when an event occurs and one (or more) condition is met. The active rules ensure automatic processing [8]. The approaches of UML permit you to extend and customize UML for specific domains or platforms by extending its meta-classes (class,

property, etc.) The three extension mechanism is defined:

- Stereotypes
- Tagged Values
- Constraints

A stereotype is an extension of a UML meta-class, and represented with notation <<stereotype-name>> and/or an icon. Tagged values are meta-attributes; defined as stereotypes properties. And a set of constraints should be attached to each stereotype which formulate the application semantics.

### III. AN IMPLEMENTATION OF ACTIVE STREAM DATA WAREHOUSE

Alert systems are usually implemented using data stream management systems (DSMSs) depicting fig. 2. Therefore, it is possible to implement model of Active Stream DW by using an architecture based on a commercial DSMS [13].

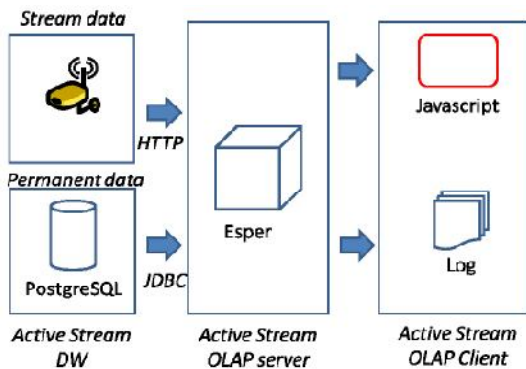

Fig.2 Active Stream Data Warehousing Three-tier Architecture Courtesy by : Bimonte 2019

#### a. Active Stream Data Warehouses (ASDW)

The Active Stream Data Warehouses (ASDW) Warehoused data are combination of denormalized relational table and normalized relational table. Stream data are stored in the main memory using the Esper (DSMS) Data Stream Management Systems have to adapt to the concept of data streams on various levels, like query languages, processing or optimization. Esper is an open-source Java-based software used for Complex event processing (CEP) and Event stream processing (ESP) in fig. 3 , which analyzes series of events for drawing conclusions.

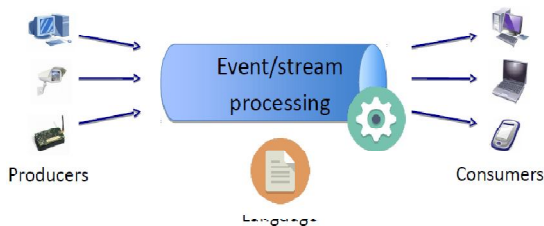

Fig. 3 Event / Stream processing Courtesy by : Alessandro Margara et. al

Classical data, which are stored using the PostGIS is a spatial database extender for PostgreSQL object-relational database shown in fig.4. Spatial databases store geographic objects in either vector or raster based formats, which allows effective and efficient management and organisation of geospatial data. It provide a additional support for geographic objects allowing location queries to be run in SQL database by the Open Geospatial Consortium (OGC).

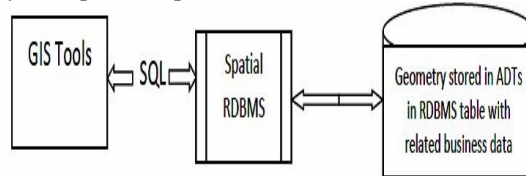

Fig. 4 Third Generation GIS

Courtesy by : <http://postgis.net/workshops/postgis-intro/introduction.html>

These data are structured according to the “stream star schema”. A logical design inspired from the classical relational schema called “stream star schema”. The stream star schema is composed of: A denormalized relational table for each dimension in order to avoid joins operations between levels of hierarchies; A normalized relational table for representing the fact that is associated to the stream.

#### b. Active Stream OLAP server

The Active Stream OLAP Server is in charge of triggering continuous window OLAP queries on top of the Active DW tier. The implemented Active Stream OLAP Server as a Java application. Using an XML file, the Active Stream OLAP Server tier allows mapping the concepts of dimensions and facts on top of the stream star schema model.

#### c. Active Stream OLAP Client

The client is a web application for Tomcat. Using a tabular representation, the client shows the results of the queries triggered by the OLAP server over the DW tier. When a new query is triggered using the ECA rules, the tabular representation is updated.

#### d. Implementation of ASDW using MagicDraw UML

MagicDraw UML is software modeling tool with business process, architecture software, system modeling, and Documentation Writers, by way of teamwork support. MagicDraw is pure Java application. This tool facilitates analysis and design of Object Oriented (OO) systems and totally supports all the diagrams the UML standard defines and Object Management Group UML (OMG UML 2) modeling language. MagicDraw converts UML diagrams into code: Java, C++, C#, XML schema and Corba IDL. Reverse engineering of code into UML diagrams: DDL, WSDL, Java, C++, C# and XML schema

#### IV. THE CONCEPTUAL FRAMEWORK

The propose ICSOLAP (Integrity Constraints for SOLAP) UML profile for the conceptual design of spatial data warehousing (SDW) in fig.5 & 6. The outline is planned into two parts: one describing the SDW multidimensional structures (SDW meta-model) and the second representing how measures are aggregated with respect to decision makers analysis needs (Aggregation meta-model). The SDW meta-model makes it possible to conceptually represent classical and advanced aspects of spatio-multidimensional modeling, such as multiple and complex hierarchies and many-to-many relationships between facts and dimensions. The profile defines a stereotype or a tagged value for each spatio-multidimensional element.

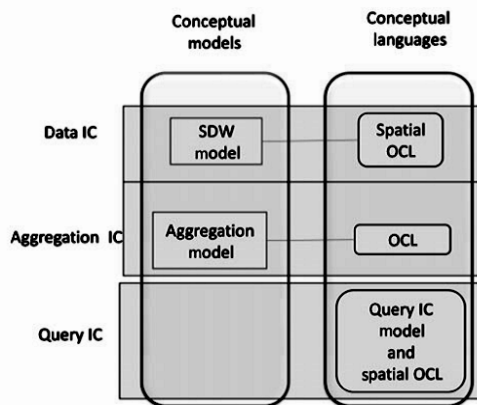

Fig. 5 The UML/OCL Object Constraint Language -based conceptual framework for ICSOLAP. Courtesy by : K. Boulil et al. 2014

IC: Integrity Constraint; OCL: Object Constraint Language; UML: Unified Modeling Language; SDW: Spatial Data Warehouse; SOLAP: Spatial OnLine Analytical Processing.

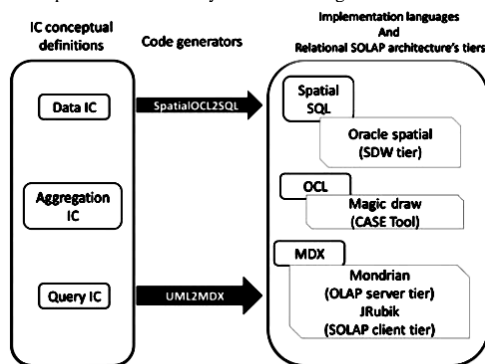

Fig. 6 The framework for an automated implementation of ICSOLAP. Courtesy by : K. Boulil et al. 2014

#### V. RELATED WORK

Common examples of streaming data include:

- Click-stream data from apps and websites
- Server and security logs

- Real-time advertising
- IoT sensors

Streaming architectures need to be able to account for the unique characteristics of data streams, which tend to generate massive amounts of data (terabytes to petabytes) that it is at best semi-structured and requires significant pre-processing and Extract, Transform and Load (ETL) to become useful. Stream processing used to be a 'niche' technology used only by a small subset of companies. However, with the rapid growth of SaaS, IoT and machine learning, organizations across industries are now dipping their feet into streaming analytics. Data stream warehouse is for many applications investigate three-tier architecture for loading streams into a warehouse that generalizes the classical ETL tool [9]. The propose system that allows queries on recent data and deep analysis on historical data [10]. A dedicated algorithm to make it possible to join a fast stream of source updates with a disk-based relation respecting a constraint space [11]. The streaming warehouse update problem as a scheduling problem and different algorithms were proposed [12] Several prototypes and systems were developed. The main systems were DataDepot [8]. Several ways to design ADWs on the problem of a real-time data refresh by proposing a real-time ETL process based on algorithms to establish suitable joins between data streams and data. and combines historical data with non-persistent data [13]; then collected in data stream warehouses. Real-time data are processed and combined with historical data to produce modern information. Business Intelligence systems associated with real time must be adapted to process the data at an increasingly faster rate and to respond within an increasingly shorter time [14] From a conceptual point of view alone, [13] provide a UML profile for SDW. XML based approach are proposed for XML DWs, where warehoused data is stored in the form of XML documents [15] only Active rules are stored as XML documents where as DWs data is stored in a DBMS and DSMS and only.

#### VI. CONCLUSION

ICSOLAP UML profile that is implemented in the CASE tool MagicDraw. A new paradigm of Big Data analytics is real-time streaming data using continuous queries so that it is possible to continuously perform analysis on the fly within the stream where streams are flowing from their production site to the datacenters, unbounded, unordered, global scale datasets. In many instances they are often referred as Fast Data, due to their small item size and high processing rate. A pipeline fashion stream computing applies a series of operations to each element in the stream. The more sophisticated, and conceptual modeling tools are consequently mandatory for successful Business Intelligence (BI) projects. In this paper we study the propose concept of Active Stream

---

Data Warehouse (ASDW) able to support real time decision systems. The design of ASDW helps to investigate a new UML profile which extends [18] to take into account continuous and window OLAP queries. A set of ECA rules to automatically trigger OLAP operators with the stream and OLAP decision-making process.

### REFERENCES

- [1] Torlone, R. (2003). Conceptual multidimensional models. In *Multidimensional databases: Problems and solutions* (pp. 69-90). Hershey, PA: IGI Global.
- [2] Kimball, R. (1996). *The Data Warehouse Toolkit: Practical Techniques for Building Dimensional Data Warehouses*. New York: John Wiley & Sons.
- [3] Vaisman, A., and Z. Esteban. 2014. *Data warehouse systems: Design and implementation*. Heidelberg: Springer.
- [4] Mohania, M., U. Nambiar, M. Schrefl, and M. Vincent. 2009. Active and real-time data warehousing. In *Encyclopedia of database systems*, ed. L. Liu, and M. T. Özsu, 28. Boston, MA: Springer US. doi:10.1007/978-0-387-39940-9\_8.
- [5] Thalhammer, T., M. Schrefl, and M. Mohania. 2001. Active data warehouses: complementing OLAP with analysis rules. *Data & Knowledge Engineering* 39 (3):241-69. doi:10.1016/S0169-023X(01)00042-8.
- [6] Shodhgangashodhganga.inflibnet.ac.in bitstream 09chapter 1
- [7] Jalel Eddine Hajlaoui, Nesrine Hamdani. 2014. Active data warehouse: Review, challenges and issues. *World Symposium on Computer Applications & Research (WSCAR)* IEEE DOI: 10.1109/WSCAR.2014.6916824
- [8] Sandro Bimonte, Omar Boussaid, Michel Schneider, Fabien Ruelle 2019. Design and Implementation of Active Stream Data Warehouses. *International Journal of Data Warehousing and Mining* 15(2):1-21. DOI: 10.4018/IJDWM.2019040101
- [9] Balazinska, M., Kwon, Y., Kuchta, N., & Lee, D. (2007, January). Moirae: History-Enhanced Monitoring. In *CIDR* (pp. 375-386).
- [10] Golab, L., Johnson, T., Seidel, J. S., & Shkapenyuk, V. (2009, June). Stream warehousing with DataDepot. In *Proceedings of the 2009 ACM SIGMOD International Conference on Management of data* (pp. 847-854). ACM.
- [11] Polyzotis, N. Skiadopoulos, S., Vassiliadis P., Simitsis A., & Frantzell N-E. (2007). Supporting Streaming Updates in an Active Data Warehouse. In *IEEE 23rd International Conference on Data Engineering ICDE 2007* (pp. 476-485).
- [12] Golab, L., Johnson, T., & Shkapenyuk, V. (2012). Scalable scheduling of updates in streaming data warehouses. *IEEE Transactions on Knowledge and Data Engineering*, 24(6), 1092-1105. doi:10.1109/TKDE.2011.45
- [13] Bimonte, S., Schneider, M., & Boussaid, O. (2016). Business Intelligence Indicators: Types, Models and Implementation. *Int. Journal of Warehousing and Mining*, 12(4), 75-98. doi:10.4018/IJDWM.2016100104
- [14] Popeanga, J., & Lungu, I. (2012). Real-Time Business Intelligence for the Utilities Industry. *Database Systems Journal*, 3(4), 15-24.
- [15] Pardede, E., Rahayu, W., & Taniar, D. (2008). XML data update management in XML-enabled database. *Journal of Computer and System Sciences*, 74(2), 170-195. doi:10.1016/j.jcss.2007.04.008
- [16] Event/Stream Processing Alessandro Margara Politecnico di Milano
- [17] <http://postgis.net/workshops/postgis-intro/introduction.html>
- [18] Boulil, K., Bimonte, S., & Pinet, F. (2015). Conceptual model for spatial data cubes: A UML profile and its automatic implementation. *Computer Standards & Interfaces*, 38, 113-132. doi:10.1016/j.csi.2014.06.004



## A Pulse Based Automated System Review for Nadi Parikshan

**Vandana Chaudhari<sup>1</sup>**,  
<sup>1</sup>Smt.G.G. KhadseCollege,Muktainagar,India  
vandu2108@gmail.com

**Manoj Patil<sup>2</sup>**  
<sup>2</sup>School of Computer Science KBC North Maharashtra  
University,Jalgaon,India  
mpp145@gmail.com

**ABSTRACT:**

*Now a day's human disease can be diagnoses by using various medicinal instruments, among that many looks inside of patient's body like MRI, X-Rays, city Scan etc.. Many times the actual problem not detected by this system. According to Ayurveda one of the best part of human body is wrist. Wrist pulse signals can be used as diagnose the disease which called as "NadiParikshan".Using the Artificial Intelligence domain possibility to creation of automated system which can sense the wrist pulses and detect the disease. In this paper describe the review and proposed work of automated disease recognition system forparikshan.*

**Keywords:** Nadiparikshan, Machine learning, Ayurveda.

**Introduction**

One of the traditional remedy and natural medicinal system in India is "Ayurveda". NadiParikshan verdict any disease using wrist nadi pulse is a system to diagnosis and dictate the associated information of the human body. The organs under pain is zeroed down by sensation palpation from using the index, middle and ring fingers placed on the radial artery. The dictate pulsations shows the physical status of the whole human body [8].NadiParikshan is very tedious and delicate process so it requires more practice and experience to master in this art. Following Fig.1 shows the traditional method in Ayurveda for NadiParikshan.



Fig. 1 Traditional Method

Human body is considered as a composite of three humors Vata, Pitta and Kapha. Vata – The Principle of movement and Impulse, Pitta– The Principle of assimilation and transformation, Kapha – The Principle of stability [3]

**Literature Review**

Chauhan et.al. described comparative study of various techniques for pulse sensing. Discussed techniques as using Microphone, Pressure as a sensor, Bi-Sensing Pulse Diagnosis Instrument for pulse sense. During comparative study author suggested various methods for signal feature extraction and classification techniques. FFT, HHT, Autocorrelation by FFT and HHT used for microphone techniques. Fuzzy logic and machine learning algorithm used for pressure transducers. [7]

Selvan et.al. developed a model for nadi reading and dictate the possible disease from the patient wrist pulse reading. Fig. 2 show the setup given by author for wrist pulse reading (vata, Pitta, Kapha). System feeds data into developed application for signal plotting into pulse wave form graph to determine the probable disease [8].

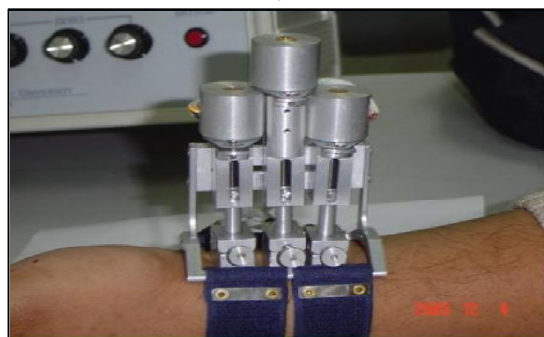

*Fig.2 setup of reading the (Vata, Pitta, Kapha) [8]*

Joshi [1] and Sharmila Begum [3] et.al. used Millivolt Output Medium pressure Sensor having 0-4 inch H2O) pressure range. Fig. 3 shows the line diagram of

NadiTarangini suggested by the author. The sensor system is mounted of the wrist to sense three location pulses for kapha, vata and pitta. The electrical signal digitized using the 16-bit multifunction data acquisition card NI USB-6210 having interface with computer. Captured the data at the sampling rate of 500Hz for predetermined time length. LabView data acquisition software used to control the digitization. Suggested to use rigorous machine learning algorithms to classify the signal data.

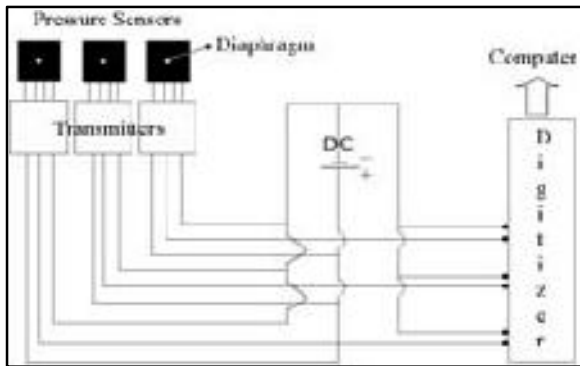
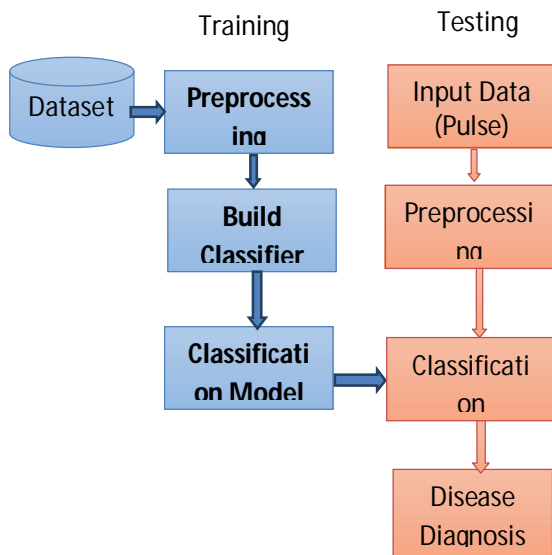

Fig.3 Line diagram of NadiTarangini[1]

**Propose Work:**

Following Fig.4 shows the block diagram of automated disease diagnosis system. System shows two phases as training and testing. System model is trained on the collected pulses data. The test data is classified according to the generated training classifier model.



**Algorithmic Steps of propose work:**

Step1: Wrist pulse data acquisition using the sensors.  
 Step2: Process the pulse data according to need of our experiment.

Step3: Manually tag the data according to its class using expertise opinion.  
 Step4: Preprocess the data to remove any noise if any. Get trained dataset.  
 Step 5: Build Classification model using machine learning techniques on dataset.  
 Step6: Automatically diagnosis the disease.

**Conclusion**

This paper describe the proposed work to automatically identify the disease using wrist pulse signals and Machine learning algorithm. Proposed automated system gives new track for the doctors to detect and diagnosis the disease in early stages which useful for human to cure in early phases.

**References**

1. Aniruddha Joshi, Anand Kulkarni, SharatChandran, V. K. Jayaraman and B. D. Kulkarni ,NadiTarangini: A Pulse Based Diagnostic System, Proceedings of the 29th Annual International Conference of the IEEE EMBS, CitéInternationale, Lyon, France August 23-26, 2007
2. Dhanalaxmi .Gaddam, A Survey on NadiPareeksha for Early Detection of Several Diseases and Computational Models using Nadi Patterns, (IJCISIT) International Journal of Computer Science and Information Technologies, Vol. 6 (4) , 2015, 3424-3425
3. M.Sharmila Begum, R.Duraiarasan and P.J.Dhivaakar, Diagnosing Diseases Through Pulse Using Pressure Sensor, 2012 International Conference on Data Science & Engineering (ICDSE), IEEE
4. Mr. Bharat S. Shete,Dr.Prof. A. B. Kakade,Pulse Diagnosis Based Automated Diagnostic System, International Journal Of Computational Engineering Research / ISSN: 2250-3005 IJCER | Mar-Apr 2012 | Vol. 2 | Issue No.2 |375-378
5. Nanyue W, Youhua Y, Dawei H, Bin X, Jia L, Tongda L, Liyuan X, Zengyu S, Yanping C, Jia W. Pulse diagnosis signals analysis of fatty liver disease and cirrhosis patients by using machine learning. Sci World J 2015
6. Prof.SumitraPundlik , PritamRikame, NeerajUpadhyay, MayureshKakade, YashTatkondawar, Wrist Pulse Analysis-A Survey, International Journal of Computer Engineering and Applications, Volume XI, Special Issue, May 17, www.ijcea.com ISSN 2321- 3469
7. Romil Chauhan, Yash Jain, Harsh Agarwal, KhushaliDeulkar, Comparative Study of Various Techniques to Diagnose Disease Using Pulse Sensing, 2016 3rd International Conference on Advanced Computing and Communication Systems (ICACCS - 2016), Jan. 22 – 23, 2016, Coimbatore, INDIA
8. Selvan, T.T.; Begum, M.S., "NadiAridhal: A pulse based automated diagnostic system," Electronics Computer Technology(ICECT), 2011 3rd International Conference on , vol.1, no.Pp.305,308, 8-10 April 2011.
9. Suguna GC, Veerabhadrapa ST, A review of wrist pulse analysis, Biomedical Research 2019; 30 (4): 538-545, ISSN 0970-938X

## A Review study on: How Artificial Intelligence can help Businesses

**Mr. Yogesh N. Chaudhari**  
Assistant Professor  
KCES's IMR, Jalgaon

**Prof. Dr. B.H.Barhate**  
Associate Professor  
BASPONC College, Bhusawal

**ABSTRACT:**

*Artificial intelligence (AI) extracts meaningful insights from raw data to quickly solve complex, data-rich business problems. Artificial intelligence in business helps in enhancing business scalability and improving business operations for companies across the globe. Artificial intelligence tools and numerous AI algorithms have gained tremendous popularity in the business analytics community. AI algorithms learn from the data iteratively and allow computers to find different types of hidden insights without being explicitly programmed to do so. AI is evolving at such a rapid rate and is mainly being driven by new computing technologies.*

*In this paper explains what is business? What are the needs of business? How AI is useful in business and features of AI. Therefore, organizations can now benefit by understanding how businesses can use Artificial intelligence and implement the same in their own processes.*

**Keywords:** Artificial intelligence (AI), Business Needs, Use of AI in business.

### 1. INTRODUCTION

The meaning of artificial Intelligence (AI) is composed of two words artificial & intelligence. The meaning of intelligence is the capacity to learn and take care of issues. The meaning of artificial is "to make computers smart with the goal that they can act cleverly.

A business is defined as an organization or enterprising entity engaged in commercial, industrial, or professional activities. Businesses can be for-profit entities or non-profit organizations that operate to fulfill a charitable mission or further a social cause.

### 2. NEEDS OF BUSINESS

Business needs are the gap between the current state of a business and its objectives. Needs are the basic drivers of change in an organization that are identified

as requirements and implemented by hiring people, implementing projects, transforming operations and purchasing goods. The following are the common types of business needs.

- **Talent:** Individuals with the ability to achieve the objectives of a firm. For instance a design director who can develop products that sales well.
- **Infrastructure:** Foundational services such as network and computing.
- **Facilities:** Facilities such as offices, factories, warehouses, data centers, retail locations and product showrooms.
- **Processes:** Business Processes such as order fulfillment.
- **Standard & Practices:** A consistent way of doing things as defined by principles, policies, procedures and standards.
- **Systems:** Software that automates works.
- **Applications:** Software that people use as a tool to improve productivity.
- **Knowledge:** Known-how and different kinds of information, for example, situational awareness.
- **Data:** Data that is intended to be utilized by machine. For instance, a billing database that is used to generate customer invoices each month.
- **Machines:** Physical machine that perform work.
- **Tools:** Physical tools that individuals use to perform work such as a mobile device or sledge.
- **Capabilities:** Business capabilities such as the ability to recruit talent and issue checks.
- **Structures:** Organizational structures such as departments and teams with their own objectives and capabilities.
- **Relationships:** Relationships with stakeholders such as investors, partners, customers, employees, regulators and communities.
- **Organizational Culture:** The standards, propensities and estimations of a firm. For instance business may need to change its way of life to be progressively inventive and tolerating of progress.

- **Intellectual Property:** Important information that is claimed by a firm including competitive innovations and licenses.
- **Product and Services:** The worth that a firm ideas to clients.
- **Customer Experience:** The experience that a firm ideas to clients. For instance a business that requirements to improve the cordiality and tirelessness of its call community benefits so as to address poor customer loyalty.

### 3. THE WAYS IN WHICH ARTIFICIAL INTELLIGENCE CAN HELP OUR BUSINESS

Artificial intelligence (AI) extracts meaningful insights from raw data to quickly solve complex, data-rich business problems. AI algorithms learn from the data iteratively and allow computers to find different types of hidden insights without being explicitly programmed to do so. AI is evolving at such a rapid rate and is mainly being driven by new computing technologies.

Artificial intelligence in business helps in enhancing business scalability and improving business operations for companies across the globe. Artificial intelligence tools and numerous AI algorithms have gained tremendous popularity in the business analytics community. Factors such as growing volumes, easy availability of data, cheaper and faster computational processing, and affordable data storage have led to a massive Artificial intelligence boom therefore, organizations can now benefit by understanding how businesses can use Artificial intelligence and implement the same in their own processes.

#### 3.1 AI BENEFIT IN PLASTIC BUSINESS

In the past decade, it was seen that the organizations that effectively utilize big data grew 50% faster as compared to non-users. This has prompted a pattern of expanded utilization of big data in the manufacturing sector as well. Converting big data into meaningful insights has become possible because of growing artificial intelligence (AI) capabilities, in particular, Artificial intelligence (AI).

AI is a specialized branch of AI in which the machines learn from its environment or the data sets given. Artificial intelligence algorithms are employed in tasks where designing static instructions is difficult or even infeasible, such as finding patterns and anomalies, making predictions from large complex data sets.

In most recent couple of years, big tech giants, for example, Google, Amazon, and Face book have built up their own AI stages. In any case, the AI is that its application isn't constrained to the tech industry. AI applications can benefit manufacturing, specifically, plastic industry, also.

The requirement for injection molded plastic is expanding because of its utilization in a wide assortment of ventures, for example, automobile, manufacturing, electronics & consumer goods, building

& construction, and healthcare. As the plastic business extends, the need to use accessible assets in an ideal manner is expanding. This results in the growing need of incorporating AI in plastic industry.

The plastic injection molding process has various factors, for example, pressure, injection speed, barrel temperature, and so on that direct the final quality of the product. So as to have a high-quality product, it is critical to keep the entire arrangement of factors at an ideal level. In any case, absence of reliable connections between the procedure parameters makes streamlining through conventional mathematical modeling an extremely challenging problem. Along these lines, the traditional approach is to utilize physically preconfigured segregation parameters dependent on inflexible edge levels. An innovative approach that is part of the Industry 4.0 transformation exploits machine-learning algorithms and provides a new regulation tool that allows optimizing the whole set of parameters in real-time.

Unlike conventional parameter adjusting based on operator's experience, Artificial intelligence doesn't rely on domain expertise. The main source of knowledge about process properties is the authentic information, recorded by sensors from the particular molding equipment. Artificial intelligence needs sets of intermediate readings from sensors along the process together with parameters of the final product. After processing thousands of such sets Artificial intelligence learns complex dependencies between intermediate parameters and quality of the product. In other words, the system builds required prediction mathematical model by itself. This is called training of Artificial intelligence model.

After the Artificial intelligence model is trained, it can process live data from the sensors and predict the final quality of the plastic part. The precision of this expectation relies upon various factors, such as quality and volumes of training data, level data preparation and cleansing, chosen Artificial intelligence algorithms, the experience of data scientists and so on.

This new type of understanding can be used in two different ways: the first, if a ML model predicts poor final quality, a manufacturer can stop further processing a particular batch at an early stage and save energy, material and time accordingly. The second, artificial intelligence model provides an operator with extra exact knowledge into the procedure, which permits further optimization of the molding process parameters. In order to implement Artificial intelligence solutions, an organization needs to establish a full data science project that includes a number of essential steps, starting from exploring opportunities and ending with building maintenance routine for the deployed AI model.

Data acquisition and cleansing is one of the most important and also time-consuming phases of data science project. Many independent parameters can be included into a dataset for plastic injection molding process model training. Here are the most important of them: Cycle time, Material blend, Injection time, Barrel

---

temperature, Injection velocity, Pressure, Screw speed, Coolant temperature.

A general rule for initial data acquisition indicates that the more diverse data we have in hands, the more accurate model we can build. The manufacturer needs to keep a history of raw data from sensors and telemetry from tens of thousands of pressure cycles and within single injection cycle signals from sensors needs to be recorded with sufficient sampling rate.

Most of the time, data acquired from real-world equipment isn't usable with no guarantees. For example a broken sensor returns a constant value of 1500C temperature or doesn't return anything for some time until it gets replaced. The task for a data scientist is to resolve issues such as missing values, incorrect values, constants, noise, and duplicates prior to building Artificial intelligence model.

Next, the mathematical model of the molding process is being built. To the date, there is a quite extensive list of algorithms for building AI model: logistic regression, decision tree, support vector machines, artificial neural networks. Data researcher chooses the most appropriate one for each particular case or uses even a combination of several algorithms. After the model is build and tested software engineers deploy it on a runtime platform. There are a number of ways of quick integration of Artificial intelligence system into existing processes without developing the complex application.

Another implementation of Artificial intelligence technology, which has gained a significant attention of the entire manufacturing industry, is predictive maintenance systems. Downtime reduction – this is an outcome of predictive abilities of AI algorithms. Many manufacturing units run 24 hours for 365 days of the year. When the equipment breaks down, the resulting downtime leads to decreased production and a waste of raw materials. This can be prevented by conducting predictive maintenance, which raises an early warning for critical failures to avoid downtime. Data, required for building predictive maintenance system, can be divided into two main groups: first, parameters of machine health status that reflect degradation and second, failure history that allow machine mark a number of patterns as alarming.

Plastic industry is adopting AI. Business leaders in the plastic industry have realized that AI offers a real opportunity to reduce the costs and also improve the overall quality of their production.

### **3.2 USE OF AI IN BUSINESS**

AI helps in extracting meaningful information from a huge set of raw data. If implemented in the right manner, AI can serve as a solution to a variety of business complexities problems, and predict complex customer behaviors. Some of the key ways in which AI can help our business are listed here -

#### **1. Customer Lifetime Value Prediction**

Customer lifetime value prediction and customer segmentation are some of the major challenges faced by the marketers today. Companies have access to huge amount of data, which can be effectively used to derive meaningful business insights. AI and data mining can help businesses predict customer behaviors, purchasing patterns, and help in sending best possible offers to individual customers, based on their browsing and purchase histories.

#### **2. Predictive Maintenance**

Manufacturing firms regularly follow preventive and corrective maintenance practices, which are often expensive and inefficient. However, with the advent of AI, companies in this sector can make use of AI to discover meaningful insights and patterns hidden in their factory data. This is known as predictive maintenance and it helps in reducing the risks associated with unexpected failures and eliminates unnecessary expenses. AI architecture can be built using historical data, workflow visualization tool, flexible analysis environment, and the feedback loop.

#### **3. Eliminates Manual Data Entry**

Duplicate and inaccurate data are some of the biggest problems faced by the businesses today. Predictive modeling algorithms and AI can significantly avoid any errors caused by manual data entry. AI programs make these processes better by using the discovered data. Therefore, the employees can utilize the same time for carrying out tasks that add value to the business.

#### **4. Detecting Spam**

Artificial intelligence in detecting spam has been in use for quite some time. Previously, email service providers made use of pre-existing, rule-based techniques to filter out spam. However, spam filters are now creating new rules by using neural networks detect spam and phishing messages.

#### **5. Product Recommendations**

Unsupervised learning helps in developing product-based recommendation systems. Most of the e-commerce websites today are making use of Artificial intelligence for making product recommendations. Here, the AI algorithms use customer's purchase history and match it with the large product inventory to identify hidden patterns and group similar products together. These products are then suggested to customers, thereby motivating product purchase.

#### **6. Financial Analysis**

With large volumes of quantitative and accurate historical data, AI can now be used in financial analysis. AI is already being used in finance for

---

portfolio management, algorithmic trading, loan underwriting, and fraud detection. However, future applications of AI in finance will include Chat bots and other conversational interfaces for security, customer service, and sentiment analysis.

## 7. Image Recognition

Image Recognition also, known as computer vision, it has the capability to produce numeric and symbolic information from images and other high-dimensional data. It involves data mining, AI, pattern recognition, and database knowledge discovery. AI in image recognition is an important aspect and is used by companies in different industries including healthcare, automobiles, etc.

## 8. Medical Diagnosis

AI in medical diagnosis has helped several healthcare organizations to improve the patient's health and reduce healthcare costs, using superior diagnostic tools and effective treatment plans. It is now used in healthcare to make almost perfect diagnosis, predict readmissions, recommend medicines, and identify high-risk patients. These predictions and insights are drawn using patient records and data sets along with the symptoms exhibited by the patient.

## 9. Improving Cyber Security

AI can be used to increase the security of an organization as cyber security is one of the major problems solved by machine learning. Here, AI allows new-generation providers to build newer technologies, to track data and apply pattern recognition to identify anomalies. This can help risk management detect fraudulent transactions in real-time so they can be prevented. This type of "algorithmic security" can also be applied for detecting fraud, leveraging AI to quickly and accurately pinpoint threats so they can be addressed before they are able to do damage.

## 10. Increasing Customer Satisfaction

AI can help in improving customer loyalty and also ensure superior customer experience. This is achieved by using the previous call records for analyzing the customer behavior and based on that the client requirement will be correctly assigned to the most suitable customer service executive. This drastically reduces the cost and the amount of time invested in managing customer relationship. For this reason, major organizations use predictive algorithms to provide their customers with suggestions of products they enjoy.

## 4. CONCLUSIONS

To use of Artificial intelligence (AI) can serve as a solution to a variety of business complexities problems, and predict complex customer behaviors and many other things. This paper introduced the AI & business, needs of business and some of the key ways in which AI can help our business are discussed. The case study of plastic industry is also discussed which gives the full idea how AI can help in any business. To grow our business we have to use proper AI techniques. Business leaders have to realize that AI offers a real opportunity to reduce the costs and also improve the overall quality of their production and business.

## 5. REFERENCES

- 1) Annina Simon, Mahima Singh Deo, S. Venkatesan, D.R. Ramesh Babu in "An Overview of Artificial intelligence and its Applications."
- 2) <https://www.flatworldsolutions.com/IT-services/articles/how-machine-learning-can-help-your-business.php>
- 3) <https://ayehu.com/blog-practical-applications-machine-learning/>
- 4) <https://www.outsource2india.com/software/articles/businesses-benefits-machine-learning.asp>
- 5) <https://www.outsource2india.com/software/articles/machine-learning-applications-how-it-works-who-uses-it.asp>
- 6) <https://www.einfochips.com/blog/how-to-develop-machine-learning-applications-for-business/>
- 7) <https://www.geeksforgeeks.org/introduction-machine-learning/>
- 8) <https://towardsdatascience.com/machine-learning-an-introduction-23b84d51e6d0>
- 9) <https://towardsdatascience.com/introduction-to-machine-learning-for-beginners-ee6024fdb08>
- 10) <https://squadex.com/insights/top-machine-learning-use-cases-business/>
- 11) <https://simplicable.com/new/business-needs>
- 12) <http://www.businessdictionary.com/definition/business.html>
- 13) <https://www.investopedia.com/terms/b/business.asp>
- 14) <https://bitrefine.group/industries/big-data-manufacturing/107-articles/AI-articles/manufacturing-AI-article/267-source-of-innovation-for-plastic-industry>

## XAMARIN: OVERVIEW OF CROSS PLATFORM MOBILE APP DEVELOPMENT

**Ms. Poonam M. Mahajan**

Assistant Professor,  
Bhusawal Arts, Science and P. O. Nahata Commerce College, India  
amritamah@gmail.com

### ABSTRACT:

*In recent years, the mobile computing sector has been having reasonably a transformation. Android, ios and windows mobile are three mobile platforms that cover almost all smart phones in the world in 2017. Developing a mobile app involves first to choose the platforms the app will run, and then to develop specific applications for each chosen platform using platform-related toolkits. A cross-platform mobile application is an app that runs on two or more mobile platforms. Huge competition in the mobile development market is no longer allows to run applications focused on one operating system.*

*To overcome this problem rather than depending on development using native language for specific operating system it would be reliable to use to build applications using frameworks for cross-platform development. It was also observed that cross platform development was found to be cheaper and takes less time. Even though tool selection in cross platform development was difficult, it was suggested that appcelerator titanium and xamarin were selected as a preliminary starting point. Our main goal is to first study the processes of development and maintenance of mobile applications built using cross-platform mobile app development frameworks.*

**KEYWORDS:** ios, LAN, UI, WIFI, XAML.

### I. INTRODUCTION

Studies approximate that currently in 2020, there are 3.5 billion smartphones in the world and this number will increase 50% the next 5 years. Smartphones are mobile devices that run software applications such as games, social network (Facebook, Twitter) and banking apps. A native app is an app built to run in a particular mobile platform. Currently, there are three platforms that dominate the smartphone market: Android (from Google), iOS (from Apple) and Windows Mobile (from Microsoft). Application stores possess a large number of applications that run on those platforms. For example, Google Play, the official app store of Android applications, has more than 2 millions apps available to download.

The mobile computing landscape is far more fluid and fragmented than it was during the PC era and is changing much more rapidly as well. From 2008 to 2018, Android vaulted from a 4% smartphone market share to a massive 76.6%. Companies need a cross-platform mobile strategy to be elastic in the face of unprecedented innovation. They need a sustainable way to build apps that keep up with the rise of new devices and capabilities. They require efficient ways to support and maintain apps. And, they need to be more agile and deliver business value faster. Consumers and employees have a tremendous level of choice when it comes to which devices and apps they use—and which they throw away—so developers must ensure that apps are engaging and work as expected, every time and on any device.

### II. TYPES OF MOBILE PLATFORMS

There are various platforms available in IT sector for mobile solutions development such as Android, iOS, Microsoft Windows, Symbian, RIM, Bada, etc. In this paper we are going to discuss about 3 prominent operating systems that cover 95% of total smart phone users.

#### Android Mobile Operating System

Android is an open source mobile platform that depends on Linux kernel to provide common operating system services to mobile devices. Android operating system stack provides memory management, process management, network model, driver model, security and an abstraction between mobile hardware and the higher level mobile device applications. Android mobile solutions are developed using objective c native language. (Android., 2012) (Hall & Anderson, 2009)

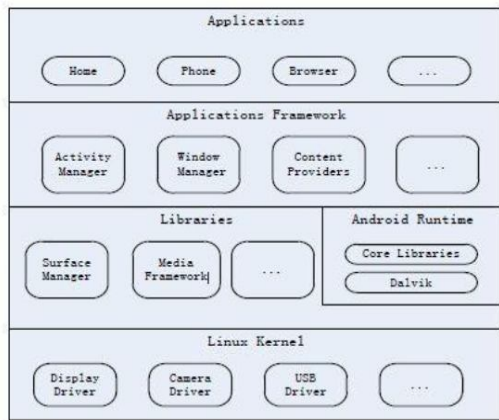

**Fig 2.1 Android System Architecture** (Chandna & Sharma, 2015)

### iOS Mobile Operating System

in 2007 Apple iPhone hit market. Apple iPhone became popular with their platform iOS. By 2011 it has become third most prominent operating system. iOS mobile applications are built using C# native language components. The iOS with its layered system architecture has since evolved to include advanced features of Voice over IP, multitasking, threading, folders, a unified mailbox and other features. (iOS 13 - Apple Developer) (ITU News, 2010)

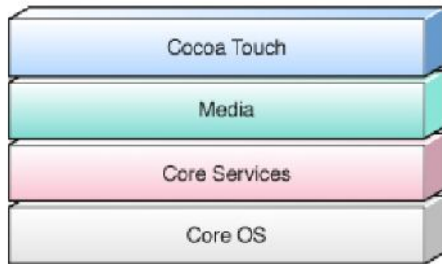

**Figure 2.2 iOS system architecture** (Android., 2012)

#### A. Linux Kernel

The kernel system service brought by Android inner nuclear layer is based on Linux 2.6 kernel. Operations like internal storage, process management, internet protocol, bottom-drive and other core service are all ground on Linux kernel.

#### B. Libraries and Android Runtime

The library is classified into two components: Android Runtime and Android Library. Android Runtime composed of a Java Core Library and Dalvik virtual machine. The Core Library gives Java core library with most functions. Dalvik virtual machine is register virtual machine and creates some particular improvements for mobile device. Android system library works as a support for the application

framework, it is also an key link binding between application framework and Linux Kernel. This system library is implemented in C or C++ language. These libraries can also be used by the different components in the Android system. They imparts service for the developers through the application framework.

#### C. Application Framework

The developer has access to all the API framework of the core programs. The application framework clarifies the reuse of its components. Any other app can release its functional components and all other apps can access and use this component (but have to follow the security of the framework). Same as the users can be able to substitute the program components with this reuse mechanism.

#### D. Android Security

The open nature of Android and its large user base have made it a charming and commercial platform to attack. Usual deeds and tool kits on the OS can be utilized across a wide number of devices, meaning that attackers can perform exploits as a whole and re-use attack vectors. Google carried out measures in the development of the Android kernel to put up security measures in; the OS is sand pitted, preventing malicious processes from intersecting between applications. Even though this attempt to eliminate the concept of contamination is admirable in some regards, it fails to mark the issue of infection altogether. Android is a sufferer of its own success, not just in the way it has fascinated malicious attentiveness, but in its very essence. One of the reasons the OS has succeeded in gaining market share too quickly is that it is non-proprietary software; it is actually free for industrialist to implement. Furthermore this has steered to substantial division of Android versions between devices and means that vendors have been unenthusiastic to roll-out updates, presumably out of some concern concerning driving demand for future devices.

#### E. Service

A Service is code that is long lasting and runs without a user interface. A good example of this is a media player playing songs from a play list. In a media player app, there would probably be one or more tasks that allow the user to select songs and start playing them. However, the music playback itself should not be controlled by an activity because the user will desire the music to keep playing even after steering to a new screen. In this situation, the media player activity could initiate a service using `Context.startService ()` to play music in the background. The system will then keep the music playback service running until it has completed. Note that you can have access to a service (and start it if it's not already opened) with the `Context.bindService ()` method. When connected to a service, you can



communicate with it through an interface revealed by the service. For the music service, this might allow you to forward, play next, etc.

### III. CODE SHARING ADVANTAGES

When building software with Xamarin, developers select one of two architectures, depending on the app being developed:

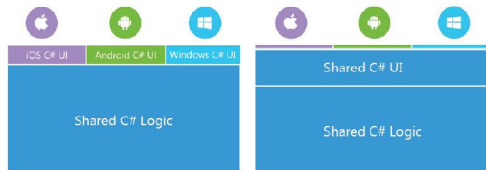

Figure 3.1 code sharing

#### A. *Xamarin.iOS / Xamarin.Android*

With the help of Xamarin.iOS and Xamarin.Android, developers implement individual user interfaces for each platform in C#, while sharing app logic (e.g. models, enterprise integrations, web services, validation, persistence), also written in C#. Developers can expect to share around 75% of their code with this approach, making apps quick to develop and easier to test, while retaining the ability to express any platform-specific UI.

#### B. *Xamarin.Forms*

Xamarin.Forms enables developers to implement their app's UI in shared C# code, further increasing code sharing up to 95% or more while still delivering a native experience. Developers write each screen of their app once in C# or XAML. At runtime, these screens and their controls are mapped to native UI elements, creating a native user experience on each platform that adheres to the design principles and user expectations of that platform. Developers can still access native UI views or functionality on each mobile platform if necessary, making Xamarin.Forms the industry's most versatile cross-platform mobile UI framework.

### IV. EXPERIMENTAL METHODS

#### A. *Video Player*

Video Player is achieved through the Eclipse platform. To develop android app, we will install a plug-ins for Eclipse: Android Development Tools (ADT). Once installed, download Android SDK (Proffitt, 2011), install and configure the SDK, then we can develop a video player. Our research starts with the study of operating paradigms, Xml customizable interface, Android platform media layer structure, Content Providers (Butler, 2011) achieves file scanning to obtain a list of media files, File parsing, MediaPlayer class, Surface Flinger interface. After that, we could develop an Android-based mobile

video player. Realize media library, video player, file opening, audio, video, photographs and other functions. The Xml file definition interface (Included in the application Framework layer) File list obtained through the Content Providers (Included in the application Framework layer) Using multimedia framework for video file playback (Included in the Libraries layer)

#### B. *MediaPlayer Class Hierarchy Diagram*

Upper JAVA program executes the underlying MediaPlayer class to implement Media streaming. First, the MediaPlayer class gets a name for media.player services through IService \_Manager getService interface. After that, all the operations are accomplished through this MediaPlayer player and the interface is IMediaPlayer. All BpXXXX classes are actually proxy classes, The responsibility is to understand message forwarding by sending the client requests to the service using the Binder mechanism. A regarding BnXXXX subclass on the service side implements specific functions. The play of final broadcast media stream is gained by executing the underlying Opencore libraries through MediaPlayerInterface interface. This class loads pre-played files through Uri, calling the OpenCore multimedia libraries to implement file parsing via JNI, by running the SurfaceFlinger interface to understand the playing of video file, by running the AudioFlinger interface to understand the playback of audio data. The software interface is feature-rich, simple, smooth operation and also by running an external program to achieve image and audio playback.

#### C. *Audio Player*

The audio player development tool is the similar as the one of video player. The process and system structure is the same as the process of video player. Also defines the interface in the Application Framework layer, and then obtains music files through ContentResolver in the Android Framework layer. Finally, plays the music with the help of the Service component calling the MediaPlayer class in the Libraries layer.

#### D. *System Structure*

The main interface module is the entry point of the application. Users will see the main interface modules after initiating the application. The module itself does not return any of the information to the user, just run list module to display. Three lists are demonstrated: album list, music list and artists list. The main interface module is recognized by calling AlbumListActivity, MusicListActivity and ArtistListActivity module.

#### E. *ListView component*

When the user chooses an element of the ListView, this module will summarize the

---

information into an intent object and send it to music playback module. Music playback module gathers the intent sent from List module and analyze it, then executes the background music services to play the audio file. The View components supplies player with some basic functions, such as pause, play, single play, random play, fast forward, fast rewind, etc. This module will accomplish the corresponding logical analysis after the users did operations to the components. Appropriate response and changes will be done as per the results analyzed. Audio player interface is shown in Start Enter the user name and password whether or not authorized OAuth certification Verify the user name and password The system main interface Weibo list Release weibo Check information Weibo square My profile ... Y N Insert the topic Insert the picture @ friends Image processing Click on the release View detailed weibo Comment weibo Forwarding weibo Collect weibo Over View @ info View comments Info View Collection Info View popular Weibo View Popular Comments View Top Favorites View personal Profile Specific functions of this system development are relied on Android Weibo SDK, calling its wrapper classes to complete the corresponding task.

For instance, the main interface is divided into three parts: the top is a toolbar, the middle area is a ListView, bottom is the button bar. Weibo List is in the middle of the main interface part, displayed through the ListView. As long as Weibo data was obtained from the service side, it will be shown directly on the ListView control through the Adapter. The function of posting is accomplished through WeiboManager.update method. This method can yield text and message containing pictures. Browse Weibo interface is used to display all the information of Weibo and realize forwarding and commenting. The interface layout file is weibo\_viewer.xml and the Weibo browse window class is WeiboViewer . When displaying the Weibo information, accessing the current Weibo Status objects and brings them to the WeiboViewer, and then executes the loadContent method to load Weibo information

## V. CONCLUSION

The development and maintenance of cross-platform mobile apps have particular challenges, different from those related to desktop or web apps. Cross-platform mobile app development frameworks

have emerged with the goal of simplify the development of cross-platform mobile apps, reduce the development, maintenance costs and the time-to-market of the apps. Our research focuses on understand the maintenance process of those apps with the aim of producing tools for improving the quality of mobile applications. The test involves three environments including hardware, software and network. Test hardware environment is Millet M1 phone and Lenovo Y460 laptop; software environment is windows 7 and phone system environment is Android 4.0.3. Network environment Mobile which is 10M broadband, WIFI LAN and Mobile GPRS network. By testing every function on mobile phone and the computer simulator, the result revealed that video player and audio player run well and no advertising. Sina weibo client can successfully complete OAuth2.0 certificate authority and login and collect the basic data of the user information from sina server and no redundant information. Desired effect is obtained after testing all the functions. Since the Weibo client has to access to the network, when tested on an Android phone, the performance under the environment of WIFI network and mobile 3G GPRS network can meet the expected requirements.

## REFERENCES

1. Android. (2012, March). Retrieved 05 24, 2020, from What is android?: <https://developer.android.com/about/versions/10/features>
2. Butler, M. (2011). Android: Changing the Mobile Landscape. *Pervasive Computing* , 4-7.
3. Chandna, A., & Sharma, N. (2015). Xamarin for Android Application. *IJCSMC* , 4 (6), 712-720.
4. Hall, S. P., & Anderson, E. (2009). Operating systems for mobile computing. *Journal of Computer Sciences in Colleges* , 25 (2), 64-71.
5. iOS 13 - Apple Developer. (n.d.). Retrieved 05 24, 2020, from iOS 13 - Apple Developer: <https://developer.apple.com/ios/>
6. ITU News. (2010, December). Retrieved 05 26, 2020, from The world in 2010: ICT facts and figures: <https://www.itu.int/net/itunews/issues/2010/10/04.aspx#:~:text=The%20world%20now%20boasts%20an,surpassed%20the%202%2Dbillion%20mark.&text=Note%20E2%80%94%202010%20data%20are%20estimates,WorId%20Telecommunication%2FICT%20Indicators%20da tabase>.
7. Proffitt, B. (2011). Open Android-For better and for worse. *Spectrum* , 22-24.

## **A Review: Artificial Intelligence vs Human Intelligence Man vs. Machine**

**Archana P.Bhalerao,  
Asst. Professor,**

DOCS&IT, BASPONC College, Bhusawal-425201, India.

### **ABSTRACT:**

*The paper revolves around a short historical perspective of Artificial Intelligence (AI) and human intelligence. Thereafter, I will go into a discussion about what constitutes machine intelligence, how it is different from human intelligence. Comparison Between Artificial Intelligence vs Human Intelligence.*

**Keywords:** Intelligence, Artificial Intelligence, Human Intelligence.

### **Introduction:**

#### **Intelligence:**

Intelligence means understanding, learning, emotional knowledge, critical thinking, and problem solving. More usually, it can be described as the ability to observe information, and to retain it as knowledge to be applied towards adaptive actions within an environment. The development of intelligence can basically be studied about in the last ten years. Intelligence involves Human and Artificial Intelligence. critical human intelligence is concerned with explaining problems, reasoning and learning. Also, humans have simple complex behaviors which they can easily learn in their entire life.

#### **Artificial Intelligence:**

There are differences between man and machine, as the human race experiences strikingly similar physical features whereas machines take various shapes and forms. I will therefore not waste too much time on appearance but instead, go into a more abstract discussion about differences in intellectuality. Accordingly, I think it is safe to say, that the research question surely demands an exploration of AI. I will argue that AI may be thought of as the possible convergence of man and machine,

just as the convergence of cables and satellites in 1980 resulted in the Internet (Briggs & Burke, 2010). It can as well be postulated that datafication in the future might converge new technologies to merge with each other, hereunder AI being one possible example. What to focus on and where to start on this subject almost deserves a paper on its own, but I argue there is one individual that will always be worth mentioning in this context: Alan Turing.

Artificial Intelligence is the intelligence demonstrated by machines as opposed to the intelligence possessed by humans. It is an umbrella term to represent technologies like intellectual computing, machine learning, image recognition, and many more. Originated in 1956 as an academic discipline, AI has come a long way over the years to reach where it is today.

The smart assistant in our smartphones Google Assistant and Siri are all powered by Artificial Intelligence elements. The services that the entertainment-related applications offer in the form of recommendations. The security the banking sector guarantees, are all heavily dependent on AI. In fact, AI has evolved to such levels where there is hardly a thing in our life that is not directly or indirectly at least, remotely, related to AI.

Hintze presents the following four types of AI:

#### **Type I – Reactive Machines**

This is the most basic type of AI since it is purely reactive and it does not consider past experiences.

#### **Type II- Limited Memory**

Unlike the sensitive machines, type II incorporates past experiences in its function.

#### **Type III-Theory of Mind**

This type is said to be the “machines of the future” wherein they can understand human emotions and predict how others would think.

#### **Type IV- Self-Awareness**

As an extension of the theory of mind, AI researchers seek to develop machines which can also form representations of themselves.

### Human Intelligence:

Human Intelligence is a quality of the mind that enables one to use knowledge acquired from existence, abstract concepts, several cognitive processes, and more, to manipulate one's environment. A machine that can, in some way 'mimic' this quality can make our lives much simpler and efficient. Human intelligence is commonly measured through IQ tests which typically cover working memory, verbal comprehension, processing speed, and perceptual reasoning. As intelligence has been defined and viewed in various ways, there have been pertinent theories. Here are some of them:

- Triarchic Theory of Intelligence (Robert Sternberg)

Intelligence is composed of analysis, creativity, and practicality.

- Theory of Multiple Intelligence (Howard Gardner)

Each individual usually has a combination of intelligence such as verbal-linguistic, bodily-kinesthetic, logical-mathematical, visual-spatial, interpersonal, intrapersonal, and naturalistic. Gardner suggested existential intelligence as also viable.

- PASS Theory (A.R. Luria)

The four processes of intelligence are planning, attention, simultaneous, and successive.

### Difference between Artificial Intelligence and Human Intelligence

#### 1. Origin of AI and Human Intelligence

AI is an innovation created by human intelligence; its early development is credited to Norbert Wiener who theorized on feedback mechanisms while the father of AI is John McCarthy for coining the term and organizing the first conference on research projects regarding machine intelligence. On the other hand, human beings are created with the distinctive ability to think, reason, recall, etc.

#### 2. Speed of AI and Human Intelligence

As compared to humans, computers can process more information at a faster rate. For instance, if the human mind can solve a math problem in 5 minutes, AI can solve 10 problems in a minute.

#### 3. Decision Making

Artificial Intelligence is highly objective in decision making as it analyzes based on purely gathered data. However, humans' decisions may be influenced by subjective elements which are not based on figures alone.

#### 4. Accuracy

Artificial Intelligence often produces accurate results as it functions based on a set of programmed rules. As for human intelligence, there is typically a room for "human error" as certain facts may be missed at one point or the other.

#### 5. Energy Used

The human brain uses about 25 watts while modern computers or machine only generally use 2 watts.

#### 6. Adaptation of AI and Human Intelligence

Human intelligence can be flexible in response to the changes to its environment. This makes people able to learn and master different skills. On the other hand, AI takes much more time to adapt to new changes.

#### 7. Multitasking

The human intellect supports multitasking as evidenced by diverse and simultaneous roles while AI can only perform fewer tasks at the same time as a system can only learn responsibilities one at a time.

#### 8. Self-Awareness

AI is still working on its ability regarding self-awareness while humans become naturally aware of themselves and strive to establish their identities as they mature.

#### 9. Social Interaction

As social beings, humans are much better at social interaction since they can process abstract information, have self-awareness, and are sensitive to others' emotions. On the other hand, AI has not mastered the ability to pick up on pertinent social and emotional cues.

#### 10. General Function

The general function of human intelligence is innovation as it can create, collaborate, analyze, and implement. As for AI, its general function is more on optimization as it efficiently performs tasks according to how it is programmed.

Artificial Intelligence	Human Intelligence
Created by human intelligence	Created by Divine intelligence
Process information faster	Process information slower
Highly objective	May be subjective
More accurate	May be less accurate
Uses 2 watts	Uses 25 watts
Cannot adapt to changes well	Can easily adapt to changes
Cannot multitask that well	Can easily multitask
Below average social skills	Excellent social skills
Still working towards self-awareness	Has self-awareness
Optimization	Innovation

---

## Summary of Artificial intelligence Vs. Human Intelligence

Artificial intelligence (AI) and human intelligence delve into technical functions such as memory, problem-solving, learning, planning, language, reasoning, and perception.

AI is also referred as machine intelligence. It was founded as an academic discipline in 1956 which is also the same year when the term “artificial intelligence” was coined by John McCarthy.

The types of AI are reactive machines, limited memory, theory of mind, and self-awareness.

Human intelligence is commonly measured through IQ tests which typically covers working memory, verbal comprehension, processing speed, and perceptual reasoning.

Some of the theories on human intelligence are multiple intelligence and PASS.

As compared to human intelligence, Artificial intelligence can process information faster using less energy.

Artificial intelligence is more objective and accurate than human intelligence.

Human intelligence is better at multitasking, adapting, social interaction and self-awareness than Artificial intelligence.

The general function of Artificial intelligence is optimization while that of human intelligence is innovation.

### Advantages of Artificial Intelligence vs Human Intelligence

- Speed of execution – While one doctor can make a diagnosis in ~10 minutes, Artificial Intelligence system can make a million for the same time.
- Less Biased – They don’t involve Biased opinions on decision making process
- Operational Ability – They don’t expect halt in their work due to saturation
- Accuracy – Accurateness of the output obviously increases
- Artificial Intelligence has significant dominance in many tasks, especially when it comes to tedious judgments.

### Conclusion:

Human intelligence revolves around adapting to the environment using a combination of different cognitive processes. The field of AI focuses on designing machines that can copy human behavior. However, Artificial intelligence researchers are able to go as far as implementing Weak Artificial intelligence, but not the Strong Artificial intelligence. In fact, some believe that Strong Artificial intelligence is never possible due to the various differences between the human brain and a computer. So, at the moment, the mere ability to mimic human behavior is considered as AI.

Also, the use of AI will surely make life even more appropriate for man in the years to come and even force humans to evolve their skill sets, it will be never possible for such machines to completely replace the human resource.

### References

1. International Journal of Electronics Communication and Computer Engineering Volume 6, Issue (5) Sept., NCRTCST-2015, ISSN 2249-071X “Human Intelligence vs. Artificial Intelligence: Survey” 3rd National Conference on Research Trends in Computer Science & Technology NCRTCST-2015
2. <http://www.differencebetween.net/science/difference-between-artificial-intelligence-and-human-intelligence/>
3. <https://www.educba.com/artificial-intelligence-vs-human-intelligence/>
4. [Lucas Kromann Nielsen December 2016 “Artificial Intelligence vs. Human Intelligence.”](#)

## IoT in Disaster Management for COVID-19S

**Dr. Gouri M. Patil,**

**Asst. Professor,**

DOCS&IT, BASPONC College, Bhusawal-425201, India.  
gourimpatil@gmail.com

### ABSTRACT:

*Internet of Things (IoT), pooled together with other technologies like Cloud Computing and AI, is of enormous application during the crisis of COVID-19. Overlaying geographic information system (GIS) on IoT mobile data can assist epidemiologists to search for patient zero. This technique can help to identify all the people who have come into contact with the infected patients. The technology can also be helpful in monitoring patients who are high-risk and hence can be a source of information to healthcare staff to take adequate action against the disease. The extended Mobile Ad-hoc Network (MANET) architecture is a most important research domain due to a wide enhancement of smart phone and open source Unmanned Aerial Vehicle (UAV) technology. UAV technology combined with IoT mapped with the realistic disaster situation.*

**Keywords:** COVID-19, GIS, IoT, MANET, UAV.

### I. INTRODUCTION

The whole world is struggle with novel corona-virus (COVID-19)[4]. Government, Healthcare officers and paramedical staff are working tirelessly to provide the best facilities to prevent citizens from COVID-19 infection. And to save those who are already infected. In these circumstances, innovations in technology are suddenly required and make divergence to healthcare systems. Countries are in preparation for battle against effects of COVID-19 and save life of people at risk.

This situation requires us to adopt a new concept □ □ 'social distancing.' Gradually, a responsible citizen is one who avoids going to public places and cares for dear ones at the same time as maintaining two meter or six feet in distance. The technologies as Internet of Things, Cloud Computing and AI becomes valuable things in this difficult times as the number of cases started growing and death rate increase. In such critical situations IoT is being used

to monitor the widespread occurrence of an infectious disease in a community at a particular time.

### II. LITERATURE REVIEW

(Amartya M, 2016) primarily focus on the extended architecture FAV. FAV is known as Flying Ad-hoc Networks, in which the cluster of Unnamed Aerial Vehicle (UAV) considered as nodes of such ecosystem that can perform a mutual task of message relay. The author proposed mobility model and emulate with a multi-UAV prototype test bed. The impact of various parameters as attitude of UAV node, GPS visibility, geometric dilution precision of satellite, and real life atmospheric phenomena like pressure, air speed upon the mobility model is analyzed through field test. Author mapped results with the realistic disaster situation [1].

### III. NEED OF IoT IN DISASTER MANAGEMENT FOR COVID-19

Recently, all over the world the corona virus is spread dangerously causing the death of numerous infected people. There is a need to control this virus by keeping the distancing without human interactions. The Internet of things, MANET, AI, GPS and Unmanned Aerial Vehicles can be the solution for this world problem. This paper focuses on some of the way to Disaster Management for COVID-19 described below.

#### Track Quarantine

A critical step to control the spread of COVID-19 is the effective quarantine of infected or supposed to be infected people. Hence countries of the entire world changed to IoT, MANET and GPS enabled applications to track as well as if necessary, restrict such people's movements. The countries should start its quarantine efforts from the airport or transportation port. Arriving passengers should bind with wristbands having a unique QR which track their movements. Passengers downloaded an app called

'Stay Home Safe' on their smart-phones and scanned the QR code. When came back to home, the person had to walk around the home to standardize the device. The basic technology is Geofencing, where a virtual boundary is created using GPS, RFID, Wi-Fi, Bluetooth signal, and cellular network.

### Smart Wearable



The smartband alert users when their body temperature is higher than 37.5 degrees. When there is movement of the human body, the smartband releases radio signals. The smartband which is the distance from another smartband can be retrieved. When two smartbands are in closeness, they vibrate, emitting an alert signal that helps people respect social distancing. The frequency of the radio signal is 2.45 GHz, the same of Bluetooth. Therefore, a future development of the smartband can devise mobile apps that communicate with the smartband using standard Bluetooth. Also, it is possible constant monitoring of very important signs, including temperature, heart rate and blood oxygen levels to alert authorities when individuals specifically those recently arrived from international, national or interstate destinations do not comply with compulsory home quarantines.

### Pre-screening or Diagnosis

When the hospitals and medical centers have to start telemedicine services quickly to diagnose and answer questions regarding COVID-19, the phone calls are overloaded. As per the observation of Partner Healthcare, Boston the average waiting time for call raises up to 30 minutes, many more of callers even dropped out within this duration. To solve this situation some of software companies have to collaborate with hospitals and medical centers to set up chatroom on their website and mobile apps. These chatrooms will ask a series of questions to screen visitors according to the severity of their conditions. This way, the doctors and medical staff don't have to answer the same questions over and over. They can instead use this time to treat patients. The India has developed Arogysetu app for pre-screening or diagnosis.

### Cleaning and Disinfecting

Cleaning, sanitizing, and disinfecting of medical facilities are very important and the infectious nature of COVID-19 further emphasizes this step. Self-driving robots are to be used for this task. Robots disinfect the surfaces by emitting high-intensity ultraviolet light and can be able to destroys the virus by destroying DNA. These Wi-fi based robots can be controlled through applications.

### Innovative Uses Of Unmanned Aerial Vehicle (UAV) technology or Drones

Innovative uses of Unmanned Aerial Vehicle (UAV) technology or drones are helpful to keep social-distancing which is essential fact of today. Drones can be used to monitor and enforce the stay at home orders, to disinfect the highly contaminated hotspot, to check temperatures of those in quarantine through infrared thermometers mounted on drones while the patients stand on their balcony or out of home on the door. Unmanned Aerial Vehicle (UAV)[1][5] technology combined with MANET can be used to fly medical samples and quarantine materials.

### Reducing In-Home Infections

Now, a day's there is awareness between people to avoid touching exposed surfaces like doorknobs, handles, light switches, ATM keypad and many more like touching mails or packages. As an alternative, they can use IoT based smart speakers, lights, security systems, etc. to open doors and switch on lights. At the same time with the stay at home orders in place, IoT [2] gives us the flexibility of video conferencing and also virtually meeting our loved ones with a simple voice command.

### Connected thermometers



Connected thermometers are being used by hospitals to screen patients and staff can use continuous temperature sensors to monitor COVID-19 patients to reduce the risks of hospital staffs. The body temperature sensors provide continuous, real-time monitoring of any changes in body temperature of patients or staff. This real-time patient data from the sensors and wirelessly transmit data to a nurse's room

---

for continuous monitoring. The normal gateway allow up to 40 Bluetooth Low Energy devices to be paired and connected simultaneously while providing the long-range connectivity needed to cover multiple rooms. Also it is possible to observe and analyze the area and location in which there is growth in temperature so that there will be more efforts to avoid infection.

### IoT Buttons



In hospitals, the smart buttons addresses the requirement for rapid deployment of facility of any size. The IoT buttons send urgent alerts to administration advising of any cleaning or maintenance issues that may cause risks to public safety. The IoT enables administration to track alerts and staff response times, as well as monitor regular cleaning activities in the high-traffic areas. The button monitors alerts issued by staff or the general public without infrastructure to operate. The battery based IoT[3][5] buttons are operated and without human intervention connect to the network and can be used in patient rooms, nursing stations, restrooms, or common areas. The buttons can be used in connected with mobile applications provides facility to track cleaning and maintenance activities.

### IV. CONCLUSION

Internet of Things (IoT), combined with technologies like Cloud Computing and AI, is helpful during the crisis of COVID-19. GIS on IoT mobile data can assist to identify all the people who have come into contact with the infected patients, also be helpful in monitoring patients who are high-risk and hence can be a source of information to healthcare staff to take adequate action against the disease. The MANET with wide enhancement of smart phone and open source Unmanned Aerial Vehicle (UAV) technology combined with IoT mapped with the realistic disaster situation.

### REFERENCES:

1. Amartya M, "A Disaster Management Specific Mobility Model for Flying Ad hoc Network", International Journal of Rough Sets and Data Analysis (IJRSDA)", Vol. 3, Issue-3, 2016, DOI: 10.4018, IJRSDA .2016070106
2. Preety Khatri , "A Relative Study About Mobile Ad-Hoc Network (MANET): Applications, Standard, Protocols, Architecture, and Recent Trends", IoT and Cloud Computing Advancements in Vehicular Ad-Hoc Networks, 2020, Pages- 18, DOI: 10.4018/978-1-7998-2570-8.ch008
3. Ram Shringar Rao, "IoT and Cloud Computing Advancements in Vehicular Ad-Hoc Networks", March, 2020, ISBN 13- 9781799825708, ISBN10- 1799825701, EISBN13- 9781799825722, DOI- 10.4018/978-1-7998-2570-8
4. Yu, Jiu-wang, Lu Wang, Li-dao Bao, "Exploring the Active Compounds of Traditional Mongolian Medicine in Intervention of Novel Corona-virus (COVID-19) Based on Molecular Docking Method", Journal of Functional Foods (2020), 104016.

### BOOK REFERENCES:

5. Rao, Ram Shringar, Jain, Vishal, Kaiwartya, Omprakash, Singh, Nanhay, "IoT and Cloud Computing Advancements in Vehicular Ad-Hoc", IGI Global Disseminator of Knowledge.



## Humanoid Robot: A Review of the Architecture, Applications and Future Approaches

**Prof. Pooja Rathi**  
BCA Department  
P.O.Nahatacollege,Bhusawals  
[Poojah1990@rediffmail.com](mailto:Poojah1990@rediffmail.com)

### ABSTRACT:

*The development in the area of the robotics, exoskeleton skill has arise a lengthy way since its beginnings in the late 60's. Researchers around the world have developed their own protocols for the exoskeleton & otherwise known exoskeleton including the MIT exoskeleton, HAL, LOPES, ALEX and many more. While technology has improved since the 60's, challenges still exist in the design of the exoskeleton. In this study, we will review the unique technology of the exoskeleton and its role in the medical field. This purpose in therapy is promising, based on uncountable of researches which have been completed.*

### Keywords:

*Body, humanoid robot, robot architecture & robotic applications*

### Introduction:

A humanoid robot is commonly defined as programmable machine which can copy the actions as well as the presence of human . A humanoid robot has a 2 main functions, which are the capacity in acquiring info from its nearby and the ability to carry out physical work, such as moving or operating objects. After the years of research & study, the presented humanoid robots nowadays have different sizes, weights and heights which linked to their application. Mostly, humanoid robots act like as a human, where , humanoid robots express their emotion by moving their eyelids & mouths. In adding, they have hands & legs so they can convey different tasks like a human and they even have the ability to study new things by using the sensors & other technologies such artificial intelligence. In short, humanoid robot is actually a robot which furnished with sensors to perceive their environment and its effectors to execute an action. This review study has

been divided into 3 main sections: the architecture, applications and future trend.

The 1<sup>st</sup> section discusses the technology or system applied to the humanoid robot. There are 4 main conditions of the humanoid robot which are the facial sensitive robot head, robot hand, robot movement and robot education behaviour.

The 2<sup>nd</sup> section discusses how the humanoid robots are being useful in changed fields such as home application, entertainment, healthcare, sport, space exploration, construction, industry and education.

The last section plans the future trend of the humanoid robot.

### Architecture:

A humanoid robot is a machine similar to human repetition. A humanoid robot is a must look like a human and act like a human being. With advances in technology, nowadays, the appearance and behavior of a humanoid robot is becoming more and more human. The following subsections discuss the technology that is being developed to make a humanoid robot look human in the face of a robot showing a robot's face, a robot's hand, a robot's location, and a robot's behavior.

### Facial robot robots:

Studies in humanoid robots have focused on the interactions between human robots. For a humanoid robot to function as a human, communication skills remain the key. In our daily communication of people and personalities, we often communicate with each other by facial expressions, gestures, and gestures, as well as in other body language. These activities are easily performed by a person and were practiced at an early age. In connection with human robots, we wish the robot to be able to do what we do. Therefore, some researchers

---

began designing a humanoid robot to mimic human performance.

One of the most important traits of a person is the ability to express emotions in the face. In everyday human communication, an adjective determines personal behavior and improves the effectiveness of communication. We always hope to interact with robots in the same way as humans. Therefore, researchers are designing robotic systems that demonstrate the art of e.g. In Japan, a human-like head robot was invented called WE3RV (Miwa et al., 2001). A human feeling like joy and anger is defined and uploaded to a robot. Once the robot has discovered the external stimulus through the sensors, the details will be changed along with the robot

Express feelings by moving various parts of the face including eyebrows, ears, eyelids, lips and a human-like mouth. For example, a Kismet robot is built in Cambridge that can generate a variety of social responses using CCD camera technology and is capable of displaying human-like expressions (Breazeal and Scassellati, 1999). The main challenge is that the humanoid robot talk cover is not sufficiently covered. For example, a person's happiness can be divided into many different levels and each level of happiness has a unique meaning. The technology of making a human head robot is constantly evolving to make the speech cover more human. Observation is also a very important act of human interaction. The speaker is used to communicate with his listener as a staring pattern that cannot speak to the speaker's position. To show respect in your speech, facial expressions are a sign of superiority or superiority in which others will look. Therefore, researchers are also considering using the power of observation in robots. For example, the researcher used the visual and touch algorithm of Honda's humanoid robot, ASIMO (Mutlu et al., 2006). ASIMO is therefore capable of viewing and displaying human hand gestures and is considered to be a storyteller. Humanoid robot control involves the acquisition of fixation points through the combination of eye movements (Gu and Su, 2006). The camera is used as the eyes of a humanoid robot. The robot's head will move depending on the item received.

### **Robot Hand:**

The hand is one of the most important human organs in performing daily tasks. Without hands, one would not finish the job easily. This is fitted with a humanoid robot, so the hands are equipped with a humanoid robot. The human hand is a complex system that is extremely difficult to duplicate in its operation and symptoms. Important features of the artificial hand that duplicate the human hand for the humanoid robot are the weight, size, size of the needle

### **Robot motion:**

As a human, walking on legs is easy. However, it's not an easy task while introducing a humanoid robot. Humanoid robots available today use bipedal locomotion technology. Currently, there are two methods used in the pedestrian field and one of them is the Zero-Moment-Point theory (ZMP). ZMP is defined as the point at the bottom where the linear line of the internal force and gravity has no substance along the axes associated with the ground (Erbatur et al., 2002). The ZMP trajectory plays an important role in measuring robots as you travel. For a possible movement pattern, the ZMP trajectory must lie within the supporting polygon defined by the location and nature of the supporting footprints. There are many humanoid robots that are designed based on ZMP-based controls, for example the Asimo Honda and WABIAN bipedal humanoid robot developed in Japan (Yamaguchi et al., 1999). Another humanoid robot named QRIO was built in Japan. In addition to walking, it can perform activities such as running and jumping. Researchers have used the ZMP stability criterion to be able to achieve elasticity and jumping (Nagasaka et al., 2004). It showed the movement of humanoid robots resembling humanity with this technology. Another option is the dynamic navigation system introduced by McGeer. This method allows the humanoid robot to move down the slope without motors or controllers (Trifonov and Hashimoto, 2008). The efficiency of the robot using this method is high (Ni et al., 2009). It is easy to control with contact foot sensors. However, there are limitations to this technology such as being unable to stand due to circular feet used, inability to start or stop moving and inability to change speed and direction. Thus, there are advancements made such as installing activators in travel robots and installing vertical drives or elasticators in other robot bomber combinations (Omer et al., 2009).

### **Study behavior of robots:**

A humanoid robot is able to communicate with a human face and body. It has the ability to use its hand to carry objects and move from place to place. However, all of this is no longer enough for our daily tasks, a humanoid robot must be able to adapt to existing forces, adapt to changes and be able to learn new skills quickly.

To achieve what is required, other methods can be used in humanoid robots such as simulation learning (Schaal, 1999). Learning to imitate means repeating that decision quickly and remembering that the third party is showing movement. For humanoid robots, the external stimulus system holds a system based on special sensors. There are known as signals used to sense movement. Sometimes, it is difficult for a human robot to mimic human action. For example, some human interests cannot be mimicked by a robot because of the limit of joints angle or flexibility issues and lack of joints. There is another similar technique

---

called graphical editing. This method allows the robot to see man-made activity. It is then extracted from the data and displays the information. Finally, robot motion is generated (Zollner et al., 2004; Calinon and Billard, 2007). Another technology that enhances the learning performance of a humanoid robot is strengthening learning. This method enables the humanoid robot to improve its performance in sequential decision-making tasks. This way, the behavior of the robot will be enhanced as the removal of complex step-by-step systems is eliminated. There are many approaches included in this approach such as reinforcement learning with the Decision T Tree (Hester et al., 2010). This method will generally be developed during model learning, hence the number of trials required for learning

### **Application:**

Developmental development of robots is improving from time to time. In the past, a humanoid robot was used only for home and entertainment applications. However, a continuous process of technological advances, these days, a humanoid robot can be used in many fields such as healthcare, sports, space exploration, construction and industry and education. The use of humanoid robots in different fields is discussed in the following sections.

### **Home Applications:**

This is a time when people are busy with work and always leave their homes neglected. So there is a need to have a robot take care of their house when they are not. Therefore, a system was developed by researchers in Japan that enables users to control one or more robots of servants in their homes remotely by telephone or internet (Sawasaki et al., 2003). This helps users see situations on the robot's site. Users can specify some locations in front of the house and assign specific tasks to the robots, so that the human-powered robot can move to predefined locations and perform tasks according to the user's need while the house is inaccessible.

### **Entertainment:**

Humanoid robots are becoming increasingly popular for providing entertainment. Humanoid robots are excellent for interacting with a person in the form of facial expressions, body language, and other body language. There are many humanoid robots that are developed for entertainment use. One example is a small humanoid robot, SDR-4X. It has the ability to go over inequalities and is able to avoid obstacles while traveling in the real world. The SDR-4X performance features a vibrant and smooth dance and is named after a program called SDR Motion creator. The main play that SDR-4X can do is dance and work for the A Cappella Chorus. In addition, the SDR-4X can also read and identify faces and usernames and

communicate with the user through its synthetic voice (Fujita et al., 2003).

### **Health:**

Humanoid robots have human-like features such as walking on horns and interacting with humans as humans. In a hospital, a humanoid robot can be used as a service robot to assist nurses and patients in their tasks and help remote people to interact with people in the hospital (Nishiyama et al., 2003). At the hospital, the humanoid robot has become an avatar for the nurse as the robot can communicate and understand the patient's needs. Patient, a patient robot, helps patients who cannot walk. The patient can also connect with the robot and view the robot as one of the users. Autism is one of the biggest developmental disorders. There are many children with autism who can have difficulty in their daily activities e.g., communication, social interaction and thinking. In this case, robots can be used as a therapeutic tool. There are two different types of humanoid robots developed especially to help children with autism. The two humanoid robots are IROMEC and KASPAR. IROMEC is a portable robotic platform and has a fan-shaped interface KASPAR is a tiny humanoid robot. Both of these humanoid robots associate children with autism in social interaction and communication skills (Iacono et al., 2001).

### **Sports:**

Sports is another important human endeavor. Because of this, researchers are studying with Res Res. J. Appl. Science Eng. Technol., 7 (7): 1364-1369, 2014 1367 for a humanoid robot to get involved in sports. Moving quickly and flexibly is the most important way to get a humanoid robot at a soccer game in Roocup. The biggest challenge to do that is instability. To solve this problem, the researcher is proposing a new fuzzy-logic control system that enables the robot to achieve faster and more flexible movements and higher turns of stiffness. This can be done by the tendency to move and to set the step length carefully.

### **Construction and industry:**

It is important to get people back humanoid robots to do dangerous work in the area. For example, construction machinery and equipment play an important role in many activities in the area. Usually, human exposure to danger while operating machinery and equipment. If a humanoid robot can operate machinery and equipment and the robot can be transferred from a remote location, then it will solve the problem of dangerous operations. The Humanoid robot also plays a vital role in a disaster area where a construction machine is needed to move large and large objects. It is dangerous for human operators to

---

work in a disaster zone. In Japan, researchers have designed a humanoid robot called HRP-1 (Hasunuma et al., 2002). It uses a mechanical drive of construction equipment such as a truck to work through the telephone. This humanoid robot can operate according to a command sent by a remote computer. The humanoid robot is limited to handling and lifting heavy objects. Most of the humanoid robots are limited to end-to-end arrivals. If a humanoid robot can interact with its surroundings in conflict, it will be able to handle and lift heavy objects. Therefore, the researcher proposed a "whole-body communication" technology. Its controller has damaged circuits to control communication status. With this technology, a humanoid robot can lift a 30 kg box with a soft response (Ohmura and Kuniyoshi, 2007).

### **Education:**

In addition to the above applications, other investigators have also begun to migrate to education. A humanoid robot called Bioloid was designed by a robot manufacturer named Robotis in Korea. Bioloid is a hobbyist and educational robot kit that aims to serve as a teaching assistant that provides a collaborative learning environment for students (Chin et al., 2011). The researcher has also proposed MicrosoftL tools for teachers to produce instructional materials and humanoid robot travel planning. Alternatively, MicrosoftL tools provide a platform for students to interact with a humanoid robot that involves other learning activities. An educational robot, Bioloid provides a great idea for students and can capture the attention of students in the classroom.

### **Conclusion:**

Humanoid robot is a very interesting field of study for its ability to gain information from its neighbors and to perform a human-like exercise. The general idea of humanoid robots is using different sensors to obtain information and perform different functions based on the information obtained using the head, hands, body and legs. The research on humanoid robots started over the last four decades, from years to years, will introduce new replacement or advanced technologies from older technologies. Much research is being revived in science fiction films such as "Star Wars", movies and "Transformers" movies and series. Recent developmental robots are increasingly coming close to fighting human behavior. Other popular humanoid robots by ASIMO are Honda, which is an astronaut-shaped robot, HRP-4 by Kawada, a small, fast and advanced robot created by the Japanese government and Nao by Aldebaran smart robots. All these humanoid robots act as human beings.

This study studied the current techniques and technologies used by researchers as a communication device for the personality of robots, hand and

locomotion system and learning behavioral technologies have been described and discussed. In the past, a humanoid robot was designed for display purposes instead of a special task or an actual application. With advances in technology in recent years, humanoid robots have been implemented in various fields as discussed in this study. However, all of the advanced robots are still in the research phase and are not really used in the real world. Future practice and challenges.

### **Caution :**

After many years of research on humanoid robots, researchers have found a good result. From a robot that can only do a man-made setup to a robot that can communicate with a human, from a robotic robot with the ability to move and make a robot with human hands and legs, researchers' contribution to the world's great success. However, it doesn't matter how much money is spent on research and development and how advanced technology is changing, when a humanoid robot becomes ubiquitous in society? This question is actually the biggest challenge the world faces. However, this will not discourage the further investigation of the humanoid robot and it is believed that the humanoid robot will become the norm in the future world. However, how long it should take is unknown. In the future, humanoid robots are expected to have better cognitive ability. Improved methods for dealing with mood disorders will be developed. Continuous advances in computer vision systems and speech recognition systems will enhance the capacity of humanoid robots to communicate with humans (Behnke, 2008). In mechanical parts, activators such as muscle activators for the safe operation of humanoid robots will be introduced near the human. Hand movements, especially the finger of shy robots, will be as easy as a human hand. In addition, humanoid robots will provide many types for their use. For example, the establishment of a humanoid submarine robot can replace a person suffering from a travel restriction and respiratory problem when entering deep sea (Mohanty et al., 2010). All of the issues mentioned above will be future challenges for investigators...

### **References -**

- 1) [https://www.researchgate.net/publication/3344813\\_The\\_evolution\\_of\\_robotics\\_research](https://www.researchgate.net/publication/3344813_The_evolution_of_robotics_research)
- 2) [https://en.wikipedia.org/wiki/Humanoid\\_robot](https://en.wikipedia.org/wiki/Humanoid_robot)
- 3) [https://en.wikipedia.org/wiki/Humanoid\\_Robotics\\_Project](https://en.wikipedia.org/wiki/Humanoid_Robotics_Project)
- 4) <https://www.servicerobots.com/humanoid-robots/>
- 5) [http://www.ais.uni-bonn.de/papers/KI08\\_Behnke.pdf](http://www.ais.uni-bonn.de/papers/KI08_Behnke.pdf)

## Document Image Noises and Removal Methods

**Prof. Lubdha. M. Bendale**

lubdha.bendale24@gmail.com  
DOCS&IT, BASPONC College, Bhusawal-425201, India.

**ABSTRACT:**

*Document Image processing is the process in which, the important paper document like annual reports , certificates, charter, concept statement, news papers, Xerox papers or many others are first scanned and then stored that scanned images in the hard Disk or any particular location. The stored images will be in compatible electronic format, which images we can access easily. Document image processing (DIP) is management of documents throughout their life cycle from creation to death. It includes the capture of documents as digital images, typically by means of document scanners, and the storage, indexing, retrieval, processing, transmission, and printing of these documents. Document images contaminated by noise during scanning, transmission or conversion to digital form.*

**Keywords:** Noise-Marginal, Max & Min, Median, Wiener, Midpoint

**INTRODUCTION**

**Document Image Noises and Removal Methods**

There are several noises on digital document images i.e. Marginal noise, background noise, clutter noise, Edge noise, Rule line noise, stroke like pattern noise, salt and pepper noise.

**1) Marginal Noise:**

In Document digitalization, the old books are translated into digitalized form by scanning the pages of old books. The resulting images contain noise likes dark region, shadow of side page , folds shadow ,handwritten text around the margin of document images is known as the marginal noise.

**2) Background Noise in document image:**

The old document are scanned, then there is a some background noises in the scan document like interfering strokes , black spots, uneven contrast , background color, shadow of splits of

papers , humidity absorbed by paper in different areas.

By using thresholding techniques, background noise is removing

**3)salt and pepper noise in document image**

Salt-and-pepper noise is a form of noise sometimes seen on images. Saltandpepper noise randomly scattered black +whitepixels. It is also known as impulse noise. This noise can be caused by sharp and sudden disturbances in the image signal.

➤ **There are some techniques to remove salt and paper noise.**

1)**Median filter:** Median filtering is a nonlinear process useful in reducing impulsive or salt-and-pepper noise.

2)**Max filter:** Replace the value of a pixel by the maximum of the gray levels(the brightest point) in the neighborhood of the pixel.

$$f(x, y) = \max_{(s, t) \in S_{xy}} \{g(s, t)\}$$

Max filter also known as 100<sup>th</sup> percentile filter. Max filter helps in removing pepper noise.

3)**Min filter:** Replace the value of a pixel by the minimum of the gray levels (the darkest point) in the neighborhood of that pixel.

$$f(x, y) = \min_{(s, t) \in S_{xy}} \{g(s, t)\}$$

Min filter also known a zeroth percentile filter. Min filter helps in removing salt noise.

**4) Wiener filter:**

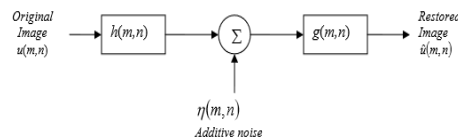

For Wiener Filter:  $G(\omega_1, \omega_2) = \frac{H^*(\omega_1, \omega_2) S_{uu}(\omega_1, \omega_2)}{|H(\omega_1, \omega_2)|^2 S_{uu}(\omega_1, \omega_2) + S_{\eta\eta}(\omega_1, \omega_2)}$

where  $S_{uu}$  and  $S_{\eta\eta}$  are Fourier transforms of the auto-correlation functions of  $u(m, n)$  and  $\eta(m, n)$  respectively.

### 5) Clutter Noise:

Clutter noise is also type of document image noises in which unwanted foreground content occurs in document image is typically larger than the text in binary images. Foreground content from numerous sources such as punched holes, stapled pins marks, folding marks, text stroke, in scan document image.

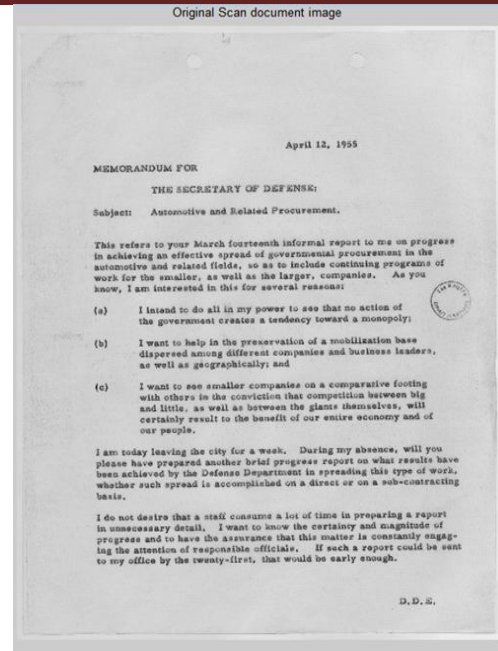
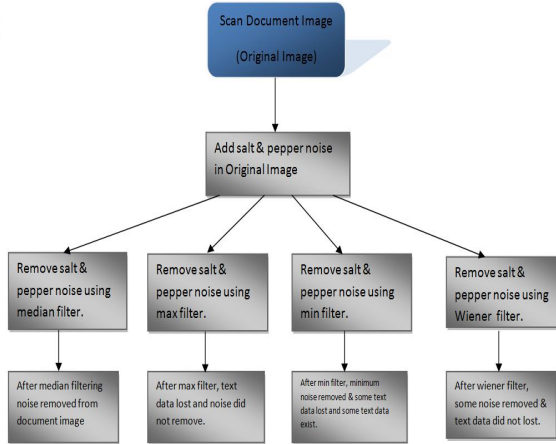

Adding Salt & Pepper noise in scan document image

### Experimental Results:

```

>> I = imread('F:\Gayatri\im1.jpg');
>> imshow(I);
>> title('Original Scan document image');
>> b=imnoise(I,'salt& pepper',0.02);
>> imshow(b);
>> title('Salt & Pepper Noise in Scan document image');
>> c=medfilt2(b);
>> imshow(c);
>> title('Remove Salt & Pepper noise using median filter From Scan image');
>> cmax=nlfilt(b,[3 3], 'max(x(:)');
>> title('Apply max filter after adding Salt & Pepper noise in Document image');
>> cmin=nlfilt(b,[3 3], 'min(x(:)');
>> imshow(cmin);
>> title('Apply min filter after adding Salt & Pepper noise in Document image');
>> d=wiener2(b);
>> imshow(d);
>> title('Apply Wiener filter after adding Salt & Pepper noise in Document image');
  
```

Original Image=>

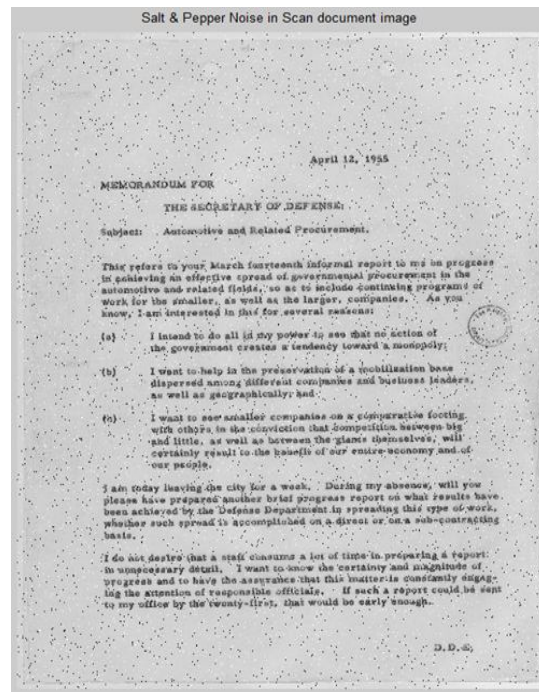

Remove salt & pepper noise using median filter from scan image.

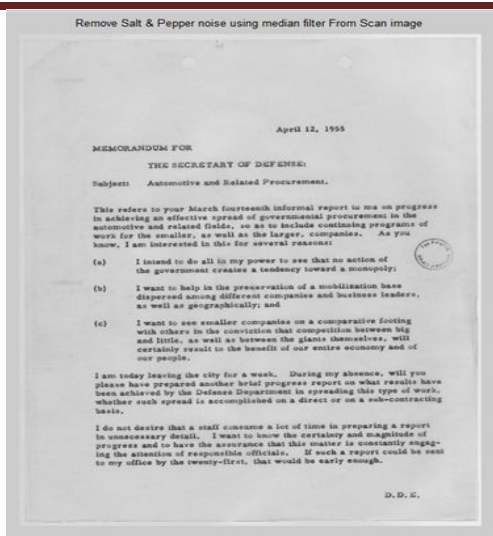

Apply max filter after adding salt & pepper noise in Document image

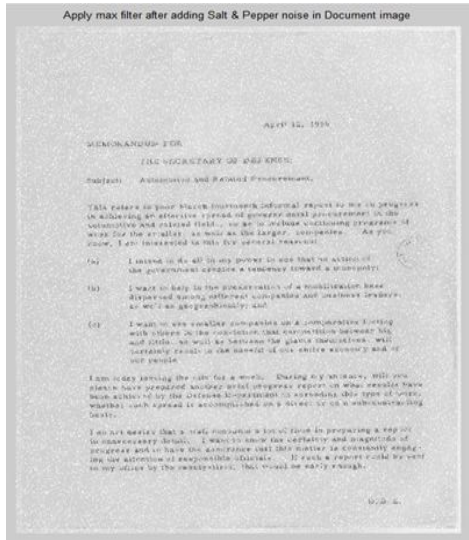

Apply min filter after adding salt & pepper noise in Document image

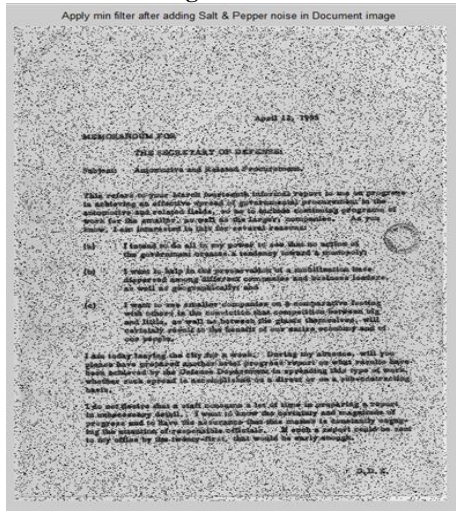

Apply Wiener filter after adding salt & pepper noise in Document image.

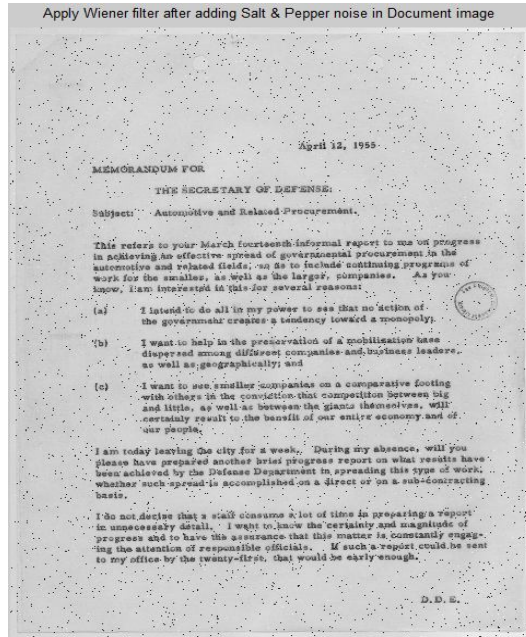

```
>> I = imread('F:\Gayatri\img3.jpg');
>> imshow(I);
>> title('Original Scan document image');
>> a=rgb2gray(I);
>> imshow(a);
>> title('Convert original scan image to grey scale image');
>> b=imnoise(a,'salt& pepper',0.10);
>> imshow(b);
>> title('Salt & Pepper Noise in Scan document image');
>> c=medfilt2(b);
>> imshow(c);
>> title('Remove Salt & Pepper noise using median filter From Scan image');
>> cmax=nlfilter(b,[3 3],max(x(:)));
>> title('Apply max filter after adding Salt & Pepper noise in Document image');
>> cmin=nlfilter(b,[3 3],min(x(:)));
>> imshow(cmin);
>> title('Apply min filter after adding Salt & Pepper noise in Document image');
>> d=wiener2(b);
>> imshow(d);
>> title('Apply Wiener filter after adding Salt & Pepper noise in Document image');
```

Original Scan document image

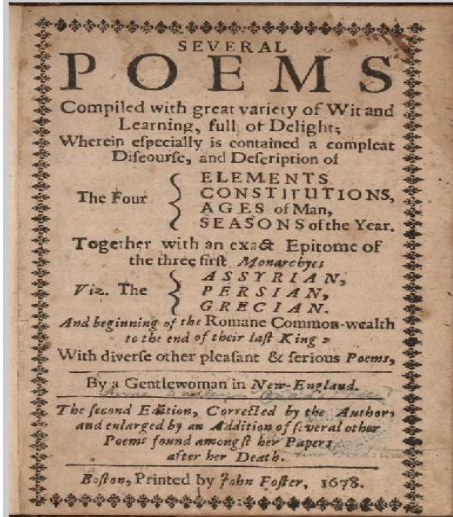

Remove salt & pepper noise from scan image using median filter

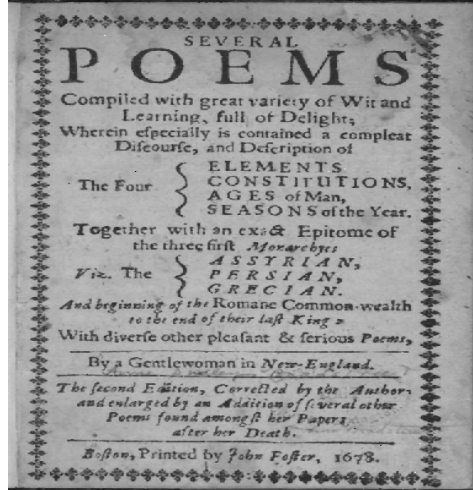

Convert original scan image to grey scale image

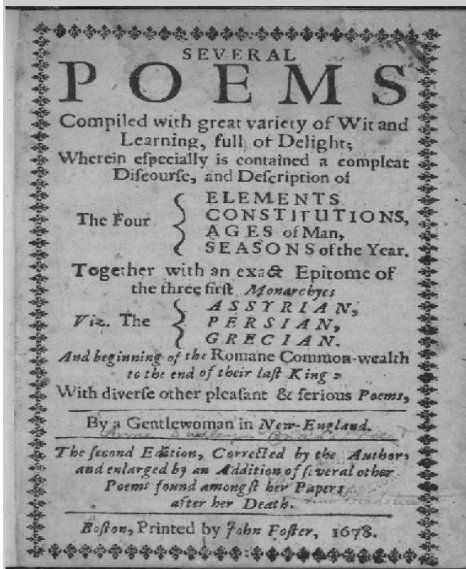

Apply max filter after adding Salt & Pepper noise in Document image

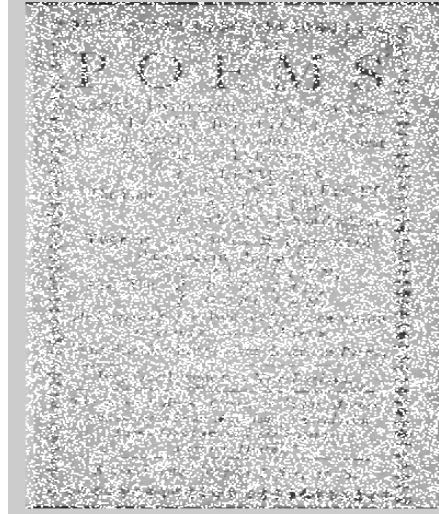

Salt & Pepper Noise in Scan document image

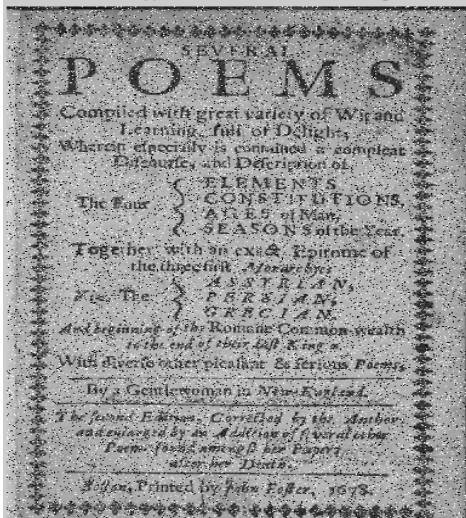

Apply min filter after adding Salt & Pepper noise in Document image

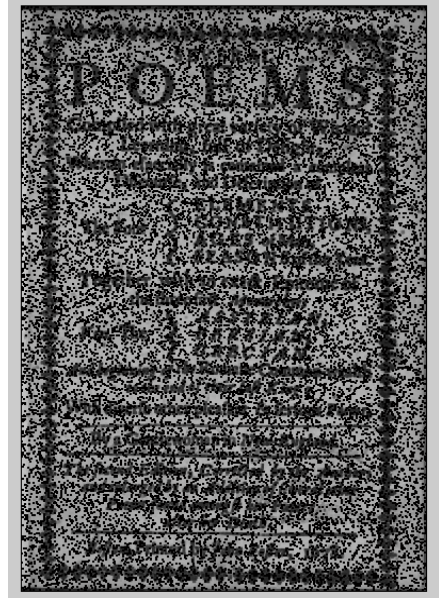



Apply Wiener filter after adding Salt & Pepper noise in document image

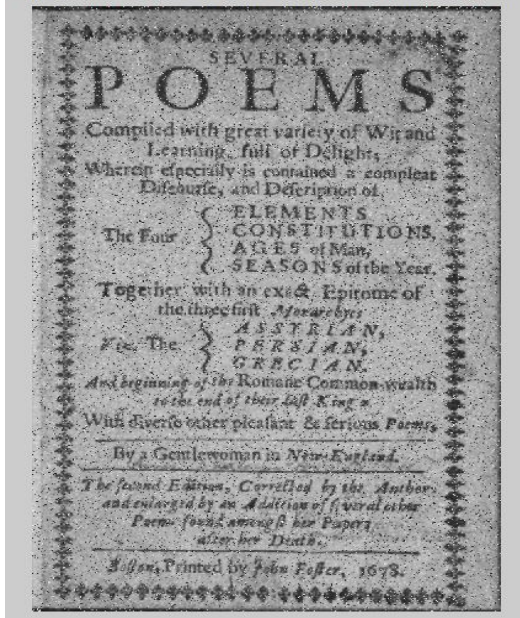

### Conclusion:

The various methods can use to remove noise from document images. This paper focuses on median, Max & Min, Wiener filters for remove noise from scanned document images . 0.02 salt and pepper noise externally added into scan document image for small text sized data and 0.10 salt and pepper noise for large text size data in scan document image. On resultant image filters applied and results compared.

Finally it concludes that Median filter is better to remove salt and pepper noise from document image than the other filter.

### References:

- 1) Retrieved from [https://en.wikipedia.org/wiki/Salt-and-pepper\\_noise](https://en.wikipedia.org/wiki/Salt-and-pepper_noise)
- 2) Retrieved from [http://nptel.ac.in/courses/117104069/chapter\\_8/8\\_16.html](http://nptel.ac.in/courses/117104069/chapter_8/8_16.html)
- 3) Retrieved from <https://www.slideshare.net/sardaralaml/filters-for-noise-in-image-processing>
- 4) Fana, K.-C., Wangb, Y.-K., & Laya, T.-R. (2002). Marginal noise removal of document images. *Pattern Recognition*, 35, 2593-2611.
- 5) Farahmand, A., Sarrafzadeh, . A., & Shanbehzadeh, J. (2013). Document Image Noises and Removal Methods. *Proceedings of the International MultiConference of Engineers and Computer Scientists, I*.
- 6) [www.cvisiontech.com](http://www.cvisiontech.com). (n.d.). Retrieved from <http://www.cvisiontech.com/library/pdf/pdf-document/document-image-processing.html>
- 7) [https://www.google.co.in/url?sa=t&rct=j&q=&esrc=s&source=web&cd=1&cad=rja&uact=8&ved=0ahUKEwiZwPCC243XAhWLPY8KHdHPAcAQFggnMAA&url=http%3A%2F%2Fwww.uta.edu%2Ffaculty%2Fkrroa%2Fdip%2FCourses%2FE5356%2Fproject7.pdf&usg=AOvVaw0N3NYEH\\_-JSkY5taXiNWQu](https://www.google.co.in/url?sa=t&rct=j&q=&esrc=s&source=web&cd=1&cad=rja&uact=8&ved=0ahUKEwiZwPCC243XAhWLPY8KHdHPAcAQFggnMAA&url=http%3A%2F%2Fwww.uta.edu%2Ffaculty%2Fkrroa%2Fdip%2FCourses%2FE5356%2Fproject7.pdf&usg=AOvVaw0N3NYEH_-JSkY5taXiNWQu)

## COVID-19 Is As An Opportunity To Indian Railway For Development

**Asst. Prof. Smita N. Bendale**

Department of Commerce & Management  
Bhusawal Arts, Science and P. O. Nahata Commerce College, Bhusawal.  
[Bendale.smita@gmail.com](mailto:Bendale.smita@gmail.com)

### ABSTRACT:

*Miss. Shilpi Bishnoi, Director, Traffic Commercial(Rates) at India's Ministry of Railway, believes that Indian Railway can use the crisis of COVID-19 as an opportunity to create a new business model by understanding the demands of its passenger & freight segments and that the railway have to focus on the three important areas for securing their future. I am just trying to put this idea in front of you for benefitting to our society. These three things can play a role of supporting backbone for Indian Railway for maintaining average in this critical condition and try to invent new business strategies for railways.*

### Introduction:

Indian Railway plays very important role for our economy and of course for the people of India. While the overall share of railways in freight traffic is around 35%, It is always trying to continuously increase the major share in transportation of bulk commodities such as coal, iron, cement, food grains which are the main runners of Indian Economy.

Year 2020-21, the national & international economy have to face the impact of the COVID-19 pandemic, which will also affect on the transportation sector, including Indian Railways. In the third quarter of 2019-2020, Indian Railway freight had already begun to show the signs of marginal decline due to reduction in the rate of core sectors of economy.

However, I can say that Indian Railway take their hold on this opportunities. IR has the choice to consider the current critical situation as an opportunity and completely try to capture its passenger and freight transportation fragments. This is the right time to look and think beyond the current year position and try to up the growth map of railways for the next 5 to 10 years.

### Objectives:

As per this study, I have to put forth some objectives that can highlight the background behind this study. It is stated as under:

1. To put the very suggestive view in front of people for getting this topic in realistic manner.
2. To focus on three important areas which state the new model of business for development of Indian Railway. The Three areas are mentioned in the research work.
3. To study the concept of re-modeling freight business.

### Scope:

The focus of this study is to restart the economy, increase the business of IR, try to apply the new mode of business which can be possible by offering the right freight rates, designing of new business strategies and by guiding the customers in reaching out to the railways, i.e. to enhance the will of doing business.

### Main body:

This is the main part of this study which help us for understanding the three major areas. These three major areas help the Indian Railway to turn around and start-up the new business.

#### 1. Acknowledge the passenger fragment:

Indian railway has for a long time, recognized the need to reduce cross subsidy from freight to the passenger segment. Since most of the passenger services are priced much below cost and continue to incur heavy losses. So, it is necessary to recognize the passenger segment. At this point of time, passenger services are completely suspended so this is the time to assess the entire passenger segment from the point of view of necessity & viability.

These criteria can be ascertained through factors like availability of alternative medias of transport,

---

affordability of rail compares to others, distance & time leads ,etc. There are the segments which are more developed road or mass rapid transportation system like metros. This is the area on which railway can work for increasing the presence of people in this segments. The railway must have to plan sector by sector strategy for completing the local requirements of people.

This period of May, June, July is just like a blank slate for Indian Railway to renovate the passenger segment from scratch. At this time, the company has to consider about the essential journey and try to clear up the situation and postpone the remaining journey. Therefore, this is the time of conducting the zero base analysis, based on which passenger services should be retained & which others should be discouraged.

## **2.Re-Modeling the Freight Business:**

As per the research, the cost of Indian logistics is higher than the other economies. It is the social obligation of passenger segment that to consider about the prices of freight traffic. After reorganization of the passenger segment, IR have to focus more on resources of freight traffic, including network capacity, rolling stock and manpower. Because of this, IR can expect about the efficient transportation & also increase the volume of freight traffic. When we rate the freight services on actual economics not on the consideration that time it is possible. Better Efficiency & higher volumes will enable IR to bring down the freight rates while increasing freight earning.

A more competitive pricing helps railways to capture the people from road to railways. This is when the railway will be at risk of losing its customers to road, but will also having the opportunity to gain traffic. This is the complete logistic solutions to customers. It is really important to bridge this gap in door-to-door logistics.

This will not only help financially to Indian Railway but also a very positive impact on the economy. The lower cost of transportation will expedite the economic recovery of most sectors.

## **3.Diversification of freight traffic:**

This is one of the important area where IR has been attempting to improve & only had moderate success so far, with various alternatives like container services, parcels, cargo express trains, road-railers etc. Industries in India have been transforming their way of transportation supply chains mesh with their manufacturing processes for a long time now. Longer transit time as well as uncertainty in transit times is not favourable for business.

Because of these limitations ,Indian Railway is not able to schedule & assured the transit time and comparative higher revenue from these models as the bulk quantity of goods carried with high volume and high rates. This cycle seems to have been broken as unintended fallout of COVID-19, and finally

passenger services and traditional goods traffic have shrunk.

The current crisis of COVID19 has given the opportunity to Indian Railway to start with a much-needed trial of scheduled parcel trains & containers cargo trains. In this period, the railway has successfully aggregated & transported parcels over long distances through to be consolidated & multiplied by chartering a medium & long-term strategy for similarly scheduled parcel trains.

## **Findings:**

This research helps the Indian Railway for deciding their further business strategy fighting with COVID-19.

This research helps for recognizing about customer segment and their local demand.

Re-modeling freight business helps the IR to focus more of its resources on freight traffic, including network capacity, rolling stock and manpower.

This is the opportunity of Indian railway to start up with parcel trains and container cargo trains.

## **Conclusion:**

It is reasonably expected that efficiency in freight operation and passenger services reorganization will provide ability to achieve punctuality in freight operations and thus attract time-sensitive cargo to rail e.g. fast moving consumer goods, pharmaceuticals, fruits & vegetables. Indian Railway can form a powerful supply chain by joining their hand with e-commerce medias and road logistics providers.

An American politician Rohm said, "You never let a serious crisis go to waste...it's an opportunity to do things you think you could not do before." This is an opportunity for Indian Railway to do zero-base assessments of services; to make rail freight more competitive & preferred option for larger sectors of the Indian Economy; & use this opportunity to emerge as a more agile force in the Indian transportation sector.

## **Reference:**

1. Sales and distribution Management A practice based approach by Ramendra Singh Vikas Publishing house pvt. Ltd.
2. Research Methodology by C.R. Kothari New age International Publishers
3. Research Methodology by R. Panneerselvam PHI Learning Private Limited
4. Organisational Behaviour by Dr. S. S. Khanka S. Chand & Company Ltd.
5. Global Railway Review
6. Personal Article: Miss. Shilpi Bishnoi

## Impact of COVID 19 on Ice cream and Cold Drinks Business

**Mr. Khilesh S. Patil**

Department of commerce and Management, BAS&PON College Bhusawal  
<sup>1</sup>. [patil.khilesh@gmail.com](mailto:patil.khilesh@gmail.com)

**Ms. Sapana R. Kolhe**

BAS&PON College Bhusawal  
<sup>2</sup>. [sapanak47@gmail.com](mailto:sapanak47@gmail.com)

### ABSTRACT:

*India's biggest makers of ice-cream and soft drinks have written to various government authorities seeking clarity on misleading information claiming chilled products spread Covid-19. Dairy major Amul has written to the central government requesting clarifications on claims made by local authorities, and even some factions of the Gujarat government, that consumption of chilled products like ice-cream spread coronavirus.*

*In Bhusawal City for ice cream and cold drinks business, the three to four months of the summer season account for over 60 per cent of the annual sales achieved. But in this year, the demand has been at its lowest position due to the extended cold weather conditions and then the corona virus (COVID 19) outbreak throughout the world.*

### Introduction :-

"Misinformation during times of a health crisis can spread paranoia, fear and stigmatization," said the letter addressed to the ministry of Ayush, Economic Times advice concerned authorities to publish claims based only on scientific evidence. The rumors have been dismissed by the UNICEF and WHO that there is no such scientific evidence, the letter signed by RS Sodhi, MD, Gujarat Co-operative Milk Marketing Federation (GCMMF), maker of Amul, said.

In states such as Gujarat, Bihar and West Bengal, local officials and police have been stopping sale of ice-cream and soft drinks alleging chilled products spread the virus, at a time when the lockdown has already wrecked sales. And RS Sodhi said.

"Ice-cream sales are down 80% compared to April last year; we are expecting in-home consumption to pick up somewhat as lockdown restrictions ease, but out-of-home is severely impacted,"

Indian Ice-Cream Manufacturers' Association (IICMA) has requested state governments to include ice-creams in the essentials list. "Irrespective of the fact that we do not see consumption to take off at least 180 days post-lockdown, the bigger challenge will be to convince consumers to come back to the category. We will have to do a lot of convincing to get them back," said Girish Pai of

Kamaths Ourtimes Ice Cream that owns Naturals ice cream

Indian Beverage Association (IBA), which represents Coca-Cola and PepsiCo too, has made direct representations to local authorities and state governments on the same. "We have witnessed local level disruptions due to misinformation. There have been clear advisories from various central ministries and assurances issued by many leading doctors as well as ICMR against any linkage between consumption of chilled products with Covid-19," said IBA secretary general Arvind Varma.

The impact of the pandemic is expected to be significant on soft drinks companies, which depend on the April-June quarter for over 50% of annual sales.

The severity of social distancing measures has negatively impacted the much larger out-of-home consumption base. Coca-Cola said last week that unit case volume declined 5% across its bottling investment group (or company's owned bottling operations) globally for the January-March 2020 quarter.

### Objectives of Study:-

1. To study Impact of COVID 19 on Ice cream and Cold Drinks Business.
2. To study comparatively sales between various types of brands of ice-cream and cold drink. In pandemic of covid.

### Limitations of Study:-

1. This study is related to ice cream and cold drink business in Bhusawal City only
2. This study's result is based on questioner send to respondents.

### Data interpretation:-

For this study we have collected some data from market. Data analysis of this data as follows

Top Leading Players in Ice Cream and Cold drinks Business in Bhusawal

### Ice cream segment:-

In ice cream segment there are mainly 3 big brand players in market such as follows

**Amul:-** Amul is well known brand in ice cream segment in Bhusawal Khandesh Food & Beverage is a Channel partner of Amul we take data from this trader for our study

**HAVMOR:-** Sachi Traders is main trader of havmor ice cream for Bhusawal city.

**CREAM BELL:-** Gauri Enterprises have main agency of creambell ice cream for Bhusawal city.

In cold drink segment there are mainly 4 big players in market such as follows

**Coke :-** Om Enterprises have rights of selling wholesale in Bhusawal market

**Pepsico india holdings :-** Pepsi is a biggest brand in cold drink segment. Nupur Agencies is a channel partner of pepsi

**Local Coldrink**

In local cold drink there are two main brands in market

1. Royal soda
2. Gokul Soda

Both are Royal soda as well as Gokul soda is have its own market. Some customers who like chip rate cold drink they prefer both local soda

We have collected data from above traders such as follows

Sales Figures in Lakhs

Brands	Supplier	Sales 2019			Sales 2020		
		MA RCH	AP RIL	M A Y	M A R C H	A P R I L	M A Y
AMUL	Khandesh Food & Beverage	19.25	22.48	30.27	1.309	1.40	1.78
HAVMOR	Sachi Traders	11.65	13.68	19.67	6.80	2.40	1.45
CREAM BELL	Gauri Enterprises	12.42	8.67	10.36	5.70	1.68	1.02
COCOLA	Om Enterprises	6.58	8.35	9.57	5.19	1.06	0.71
PEPSI	Nupur Agencies	3.95	4.78	6.46	2.48	0.78	0.36
TOTAL MONTHLY SALES		53.85	57.96	76.33	33.26	7.32	5.32

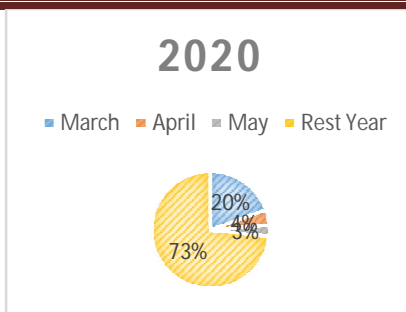
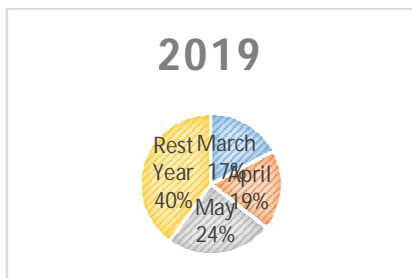

Last year annual average sales value is used in year 2020 graph to get situation of impact on market regarding yearly sales position.

2019 scenario: Roughly above graph shows that 60% of annual sales were achieved from summer season in year 2019 and 40% of annual sale was to be brought from non-summer season that is from remaining 8 to 9 months.

2020 scenario: Due to Covid 19 impact only 27% of annual sales could be achieved from this summer in year 2020 which is 55% lesser than previous year.

**Findings of this Study:-**

Looking over by the present scenario, the ice cream and cold drink business sector is headed for a near wiped out in this summer 2020.

**Covid 19 has impacted these business in 3 major ways**

1) Due to City Lockdown in Bhusawal (All Over India) makes all business close down throughout the leading summer season business.

No continue supply of goods could be possible due to inconvenience in transport facility banned in various areas red spot & hot spot areas.

2) Covid 19 regarded Mislead and False information being kept in Belief in people regarding Ice Cream & Cold drink products

There was a viral message urging people to avoid ice creams and cold drinks to prevent the novel Corona virus, which is actually misleading

But still with this false belief, it will impact for rest of the year

3) Financial Loss due to fixed monthly expenses even in no earning days

Electricity Bills Due to On going freezers for preservation of stocked frozen goods, Salary payment to workers and loss of goods due to expiry in these lockdown days

**References:-**

1. Sales and distribution Management Apractice based approach by Ramendra Singh Vikas Publishing house pvt. Ltd.
2. Research Methodology by C.R. Kothari New age International Publishers
3. Organisational Behaviour by Dr. S. S. Khanka S. Chand & Company ltd.

**Web Ref.:-**

1. <https://economictimes.indiatimes>
2. <https://www.amul.com/>
3. <http://www.pepsicoindia.co.in/>
4. <https://www.coca-colaindia.com/>
5. <https://www.havmor.com/>
6. <https://creambell.com/>

**Study of Current Strategy of Vegetables Traders of Market**  
**Mr. Khilesh S. Patil**                      **Mrs. Jayashree A. chaudhari**

Department of commerce and Management, BAS&PON College Bhusawal  
<sup>1</sup>[patil.khilesh@gmail.com](mailto:patil.khilesh@gmail.com)                      <sup>2</sup>[jachaudhari1@gmail.com](mailto:jachaudhari1@gmail.com)

**ABSTRACT:**

*Year 2020 a year which can't be forgot for next century coz of The coronavirus COVID-19 pandemic. The coronavirus COVID-19 pandemic is the defining global health crisis of our time and the greatest challenge we have faced since World War Two. Since its emergence in Asia late last year, the virus has spread to every continent except Antarctica. The pandemic is moving like a wave—one that may yet crash on those least able to cope. But COVID-19 is much more than a health crisis. By stressing every one of the countries it touches, it has the potential to create devastating social, economic and political crises that will leave deep scars. As we know when any crises hit the economy it affects from top to bottom like from billionaire business man to small farmer.*

**Introduction :-**

The spread of novel coronavirus, SARS-CoV-2, and the COVID-19 disease it causes has had unprecedented impacts on all food market, including the market for fruits and vegetables. Throughout the value chain, grower-shippers accustomed to just-in-time inventory management systems and retailers able to stock every product with minimal interruption faced shocks in both supply and demand. They have to apply day to day strategy.

Fruits and vegetables are produced seasonally, but the market requires products throughout the year. For many decades, this problem of matching product availability with consumer demand was solved in two ways: (1) selling fresh products during harvest and shortly thereafter, and (2) processing the rest to meet demand during the rest of the year.

As technology improved and consumer incomes increased, it became possible to provide fresh produce year-round. American consumers now expect fresh tomatoes, strawberries, and sweet corn every month of the year. In addition, a strong demand remains for processed fruits and vegetables.

**Fresh Markets**

Increased consumer incomes and year-round demand for fresh produce force retailers or their representatives to establish buying points both in

different growing areas of the United States and in foreign countries. Some retailers contract year-round with fresh fruit and vegetable packers, who may in turn contract with growers. Contracts and large volume

buying practices enable packers to obtain sufficient quantities of individual products.

Large fresh fruit and vegetable packers may contract with growers in several different production regions to ensure that fresh fruits and vegetables are available every week of the year. These packers generally contract only in regions

with a large number of growers. Further, they contract mainly with the largest growers, even in concentrated production regions. Some packers ensure supplies by growing commodities themselves. Large retailers and packers are unlikely to purchase products directly from a single small-scale grower, especially a grower in a remote production area.

As a small-scale fresh fruit and vegetable grower, you may consider selling directly to retailers. Although some chain stores and independent retailers have buy-local programs for fresh produce, such stores and programs are not common. You must develop your own marketing system. In effect, you must become the grower, packer, and wholesaler.

Finding smart ways to market fresh fruits and vegetables encourages customers to learn about and buy healthy food. Whether you primarily sell fruits and vegetables or a produce area is a part of your grocery store, being known as a business that provides helpful information on how to use produce is key to building customer loyalty. Implementing a variety of marketing strategies helps you appeal to all of your customers, some of whom are more knowledgeable about choosing and preparing produce than others.

**Objectives of Study:-**

To study of current strategy of vegetables traders of market

To study impact of pandemic on vegetable retail business

**Limitations of Study:-**

1. This study is related to vegetables traders of market in Bhusawal City only

2. This study's result is based on telephonic interviews of respondents.

## Research Methodology for this Study:-

We have use interview method to collect data for this study.

We had call some people including broker, agents, trader and farmer to know how they work in lockdown period.

**Sample size:** - we have taken 100 sample sizes for this study.

### Main body :-

We have telephonic interview with peoples with following data are collected

Types	No. of Respondents
Farmers	20
Brokers	10
Agents	10
Traders	60
Total	100

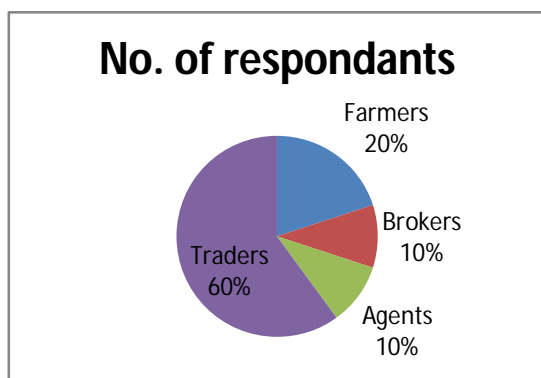

As per above digram we have intract with people and most of this peoples are traders. Rather thanm traders we have intracted with farmers brokers and agents.

Types	peoples whow agree	peoples whow disagree
Farmers	20	0
Brokers	10	0
Agents	10	0
Traders	60	0
Total	100	0

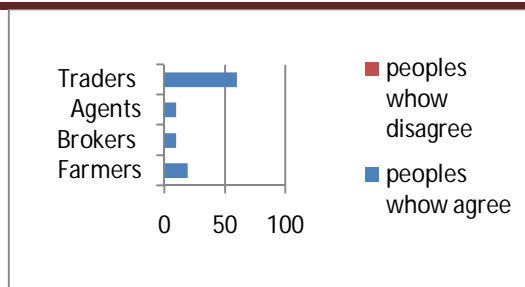

Brokers are also agree that their business also affected by covid19. As well as 100% peoples says that their business is volatile because of only covid19.

## Role of Bhusawal Municipal Council:-

Bhusawal municipal council strictly take action from first lockdown 1.0

Municipal council want to distribute people in different spaces for trade of vegetables because of covid19 and so council distribute daily market in 6 sites of Bhusawal

1. Dr. Ambedkar Ground
2. Bhusawal high school ground
3. Municipal high school ground
4. T.V. Centre ground
5. Matrubhumi chauk ground and
6. Near Nahata college vikas colony ground

Traders have to option to sell their products in various market places. Now a days they do not buy extra vegetables goods for trade they choose fresh to sell every day.

Some traders are like to do business as mobile retailer so they take this way to trade

## Giving Details

Providing details about each type of fruit or vegetable you sell helps people understand the quality and value of the produce so they feel confident buying. For instance, small cards that describe the taste of the different varieties of apples you carry, such as sweet, crunchy or sour, help people learn and appreciate more than just the color. Note where the produce comes from, such as the name of a local farm, to help the consumer realize the value and quality of the produce you carry.

## Merchandising

Displaying your produce so it's at eye level and easily visible is important to moving these perishable items as fast as possible. Add a basket near the cash register filled with seasonal fruit for sale by the piece so people can pick one up on their lunch break or as a snack. Cross-merchandise items by putting together small baskets or displays of items that go together to create a dish, such as grouping an onion, a few tomatoes, a lime and a hot pepper to suggest the ingredients to make salsa.

## Promotion

Create short surveys to ask your customers what types of fruits and veggies they'd like to see in your store or

---

stand, and then run promotions to encourage people to buy it. Feature a handful of produce items each week on banners hung in the windows and in local print ads. Provide discount coupons to help gauge the response. Share information on how to prepare the produce featured in your ads so people feel encouraged and knowledgeable about what to do with their purchases.

### **Education**

Providing nutritional information about the fruits and vegetables you sell helps make the buyer more aware of their value. Have fliers or brochures that explain how to handle and store various types of produce to encourage customers to buy more. Work with schools, community centers and clinics to raise awareness of the importance of eating daily servings of fresh produce. Offer tours of your produce area to school kids, complete with samples of in-season goodies, as a way to foster appreciation of the produce you carry.

### **Findings of this Study:-**

1. Vegetables traders' retail and whole sale business are affected due to covid19.
2. Now a day's vegetables market is volatile situation.
3. Farmers some losses due to covid19

### **References:-**

1. Research Methodology by C.R. Kothari New age International Publishers
2. <https://www.researchgate.net/>
3. extension.psu.edu
4. Bartsch, J. A., and R. Kline. *Produce Handling for Direct Marketing*. Ithaca, N.Y.: Northeast Agricultural Engineering Service, 1992.
5. Dunn, J. W., J. W. Berry, L. F. Kime, R. M. Harsh, and J. K. Harper. *Agricultural Alternatives: Developing a Roadside Market*. University Park: The Pennsylvania State University, 2006.
6. Dunn, J.W., J. K. Harper, and L. F. Kime. *Agricultural Alternatives: Cooperatives*. University Park: The Pennsylvania State University, 2005.
7. German, C., et al. *Guide to Planning the Farm Retail Market*. Newark: University of Delaware Cooperative Extension Service Agricultural Experiment Station, 1994.



*Recent Trends, Opportunities and Models in E-commerce*

**Prof. Varsha G. Patil**

[kurkure.varsha@rediffmail.com](mailto:kurkure.varsha@rediffmail.com)

Department of Commerce & Management

Bhusawal Art's, Sci & P.O. Nahata Commerce College, Bhusawal

Contact No : 7798804274

**ABSTRACT:**

*Electronic commerce is just buying and selling product online. E commerce also encompasses the entire online process of developing, marketing, selling, delivering, and paying for products and services purchased on internet. E commerce may have large economic effect in future.*

*The arrival of internet and smart phone has created a revolutionary change in the way we purchase. Ecommerce is a type of business where goods and services are offered directly to its customers without an intermediary through the website. Ecommerce enables us to order for the goods sitting at the home. The customers can select the required products from a variety of products that are available online. The payment for the product can also be done using debt card, credit card, e-cash or e-wallet. This paper discusses the recent trends in ecommerce, the opportunities and limitations of ecommerce and the various ecommerce models.*

**Keywords:** Ecommerce, Models, Business, Opportunities, Limitations.

**Introduction:**

*The term electronic commerce or e-commerce refers to all business transaction that involves the transfer of information through the internet. E-commerce covers a variety of business activities which use internet as a platform for either information exchange or monetary transaction or both at times. E-commerce means using the Internet and the web for business transactions and/or commercial transactions, which typically involve the exchange of value (e.g., money) across organizational or individual boundaries in return for products and services.*

*Electronic commerce, known as E-Commerce, occurs daily when sellers and buyers use the internet to conduct business transactions. Technology makes it possible for anyone to buy or sell practically anything online.*

**Review of Literature:**

I have taken required data from online material as well as offline material. And some details included from research paper of researchers also used some book material for e-commerce models. The details of that books and links given in references

**Objective of the study:**

1. To study the concept of E-commerce.
2. To analyse the present trends of E-commerce
3. To study the various Opportunities available in E-commerce.
4. To study the different models of E-commerce.

**Research Methodology:**

For this research paper, Data Can be collected using different sources of research methodology. Data collection is a process of collecting information from all the relevant sources to find answers to the research problem, also test the hypothesis and evaluate the outcomes.

There are two types available for data collection Primary Data and Secondary Data.

**A. Primary Data:** -Primary data is a term for data collected at source. This type of information is collected directly for first time from first hand sources by means of surveys, observations and experimentation and not subjected to any processing or manipulation and also called primary data.

**B. Secondary Data:** - It refers to the data collected by someone other than the user i.e. the data is already available and analysed by someone else. The sources of secondary data include various published or unpublished data, books, magazines, newspaper, trade journals etc. This paper study is purely conceptual and based upon secondary data which is collected from books, national journals, published reports and other websites.

**E-commerce Models:** -

**A. Business-to-Business (B2B) Model-**

B2B Model shows commerce transactions between businesses, between a manufacturer and a wholesaler, or between a wholesaler and a retailer. It is

---

the largest form of E-commerce. In this form the buyer and sellers are both business entities and do not involve and individual consumer. It is known as EDI (Electronic Data Interchange). Some years ago, EDI was conducted on a direct link of some form between the two business where as today the most popular connection is the internet. The two businesses transfer information electronically to each other.

**B. Business-to-Consumer (B2C) Model-**

In this model, business and consumer are involved. Business sells to the public typically using catalogs utilizing shopping cart software. Customer identifies need. Searches for the product or services which satisfy the need. Selects a vendor and negotiates a price. Receives the product or services, Makes payment.

Examples websites like Amazon.com, flipcart. etc.

**C. Consumer-to-Business (C2B) Model-**

In this C2B model, the customer requests a needy service from the business. Consumer to Business is a growing area where the consumer requests a specific service from the business. It enables buyer to name their own price, often binding, for a specific good or services generating demand. A consumer posts his project with a set budget online, companies review the customers' requirements and bids out the project

Examples: online trade, tenders, freelancing with website like Baze.com.

**D. Consumer-To-Consumer (C2C) Model-**

It facilitates the online transaction of goods or services between two consumers. Consumer-to-consumer (C2C) model involves the electronically facilitated transactions between consumers through some third party. A common example of C2C model is the online auction, in which a consumer posts an item for sale and other consumers bid to purchase it. The sites are intermediary just there to match consumers. examples - OLX, eBay

**Opportunities for E-Commerce**

**A. Direct Sales**

Companies can directly sell their goods and services to customers through ecommerce website. Making order for the purchase, invoice and payment, all these done using internet. The delivery of goods will be through a physical channel

**B. Presales**

Ecommerce companies can make use of their websites for promoting your sales. Companies can make use of email campaigns, search marketing or online advertising for boosting their product sales.

**C. User Interface**

The user interface allows us to search for the products easily and can order for the product in a lesser time. The customers can even filter their

products based on price, colour, Top Brands and so on.

**D. Shopping Cart**

The shopping cart allows the customer to choose the products according to their choice of interest. Add to cart options can be used to add products to our shopping cart.

**E. Payment Software**

The payment for the online purchase can be made using debit cards or credit cards. The ecommerce website will direct the customer to a payment gateway. The three main methods of payment are opening a merchant account, using a payment processing company or creating an online shop within a virtual shopping mall.

**Recent trends in e-commerce: -**

**A. Evolving role of social media: -**

The number of social shoppers is also rapidly increasing. Social media is playing an important role in the world of ecommerce. This is a great opportunity for brands for thinking about how to improve their brand position on social media, which is a great platform for brands to get discovered. With consumers spending more time on different types of social media.

**B. Role of Artificial Intelligence: -**

The role of AI will become strongest in the coming years, as retailers invest in improving areas such as customer service where AI can be useful to understand the reactions of customers to the product or service purchased. It plays a big role in solving how retailers can improve customer experience. In order to stay competitive, it's important that retailers must invest in this ecommerce trend.

**C. Mobile shopping: -**

Currently in the United States estimated that more than half of customers shop using mobile devices. In Europe 55% of customers are shopping through mobile. Ecommerce businesses are doing their best job to provide a smooth user experience on their ecommerce websites with a number of payment options including e-wallets. China is a leader in online payment, with WeChat and Alipay.

**D. Social Payment**

Social payment allows users to transfer funds using social media. Such as Apple pay, Google Wallet, Facebook payments, Twitter Buy etc. These payment methods work similar to digital bank account.

**E. Cash on Delivery -**

All Indians love cash on delivery option it gives us more control over online transactions. since we do not have to pay until product is at our doorstep.

**F. Voice Commerce -**

Almost 50% of internet searches will be done using voice search. Most of the customer use any one of virtual assistants from google, amazon,

---

Microsoft to conduct voice search when using their smart devices. It is an alternative for using keyboard or screen to purchase product online, it is not only finding the product but also helps in ordering and buying the same product.

**G. Chatbots –**

A chatbot is an AI that simulates communication with a user in natural language through websites, mobile apps, telephones or message applications.

**H. Beacons –**

A beacon is a wireless transmitter that uses low energy Bluetooth technology (BLE) to send signals to other nearby smart devices.

**I. Ecommerce product video**

Some consumer has purchased an item by watching a product description video. Video gives a better understanding of product & increases the consumer's trust. Some video demonstrates how to use the product.

**Limitations of e-commerce: -**

**A. Technical –**

- 1 Poor implementation of ecommerce due to lack of system security, standards, reliability.
- 2 Most of countries have network bandwidth issue.
- 3 Vendor must require special type of web services & other software's.
- 4 It is difficult to integrate ecommerce website or database with existing applications
- 5 Software hardware compatibility issues some ecommerce software incompatible with some as or other component.

**B. Non-Technical**

- 1 Creating an ecommerce application may be very costly

2 Users not trust on the unknown faceless sellers' websites.

3 Difficult to ensure the security or privacy in online transactions

4 Ecommerce applications changing rapidly

5 Internet access is not cheaper to those people living in remote villages

6 Consumer cannot feel and touch the product. In that situation consumer faces bit trust issues over product

7 When someone plan to order a product online, they can never assure to get delivered as per time

**Conclusion:**

E-commerce creates new opportunities for business as well as creates new opportunities for education and academics. Today E commerce becomes an integral part of everyday life. Due to fast adoption of internet enabled devices like Smartphone and Tablets, we have seen an unparalleled growth in E-commerce. The newest telecommunication technology has completely changed the way of our living, communication methods, shopping etc.

With the advancement in technology and changes in consumer behaviour, you need to keep an eye out for these ecommerce trends in 2020. It is further clearer that the number of people who are accessing e-commerce websites for their purchase will further increase in future.

**References:**

e-Commerce concept, models, Strategies [C.S.V. Murthy] Himalaya Publishing House [1]

[Dr. B Menaka, K. Seethal Research Paper on Recent Trend in E – Commerce \[2\]](#)

<https://www.economicdiscussion.net/business/e-commerce/31868>[3]

<https://www.bigcommerce.com>[4]

<https://www.tutorialspoint.com> [5]

<https://www.purchaseecommerce.com> [6]

## वैश्वीकरण के परिप्रेक्ष्य में जनसंचार माध्यमों में हिन्दी भाषा : विकास की दिशाएं एवं चुनौतियाँ

डॉ. रूपाली दिलीप चौधरी

डॉ. अण्णासाहेब जी.डी.बेंडाले  
महिला महाविद्यालय, जलगांव

भाषा मनुष्य के जीवन में अति महत्वपूर्ण है. भाषा के बीना कोई भी कार्य होना असंभव है. जिस प्रकार मानव की उत्क्रांति काल से लेकर आज तक न जाने मनुष्य ने अपनी आवश्यकता को निभाने के लिए किन संसाधनों को उपभोग में लिया. आज के पराआधुनिक दौर में अर्थात् वैश्वीकरण के परिप्रेक्ष्य में केवल भाषा का होना, समझना, ही आवश्यक नहीं तो भाषा के साथ - साथ जनसंचार माध्यमों के साथ भाषा का जूडना नितांत अनिवार्य माना गया. मनुष्य का मूल स्वभाव संचार करना है. संचार के साथ मनुष्य की भावनाएं, संवेदनाएं जुड़ी हुई हैं. जैसे जैसे मनुष्य की सभ्यता का विकास हुआ वैसे ही भाषा का भी विकास हुआ. वैश्वीकरण के दौर में जनसंचार के माध्यम को सुचारू रूप से आत्मसात करने के लिए भाषा को कई संघर्ष की यात्रा करनी पड़ी. किन्तु समय की माँग के अनुरूप भाषा ने भी जनसंचार एवं तकनीक के संसाधनों में अपना नया रूप धारण कर लिया. हमारे पौराणिक ग्रंथ भी इसका प्रमाण देते हैं, नारद मुनि की भ्रमण यात्रा, श्रीकृष्ण के जन्म के समय में होने वाली आकाशवाणी इस प्रकार की कई घटनाएं इस बात का प्रमाण हैं. पौराणिक ग्रंथों का आधार भी माना तो वर्तमान जगत में इन संसाधनों का महत्व बढ़ गया है. जनसंचार के कई साधन उस युग से लेकर आज तक विकसित हुए हैं. औद्योगिक एवं भौतिक विकास के साथ - साथ मानवीय जीवन मूल्यों में भी बदलाव आया है. इन्हीं

मानवीय जीवनमूल्यों की रक्षा करना हर एक व्यक्ति का कर्तव्य है. संतों की वाणी थी वसुधैव कुटुंबकम की परिव्याख्या को संचार के माध्यमों ने भी अपनाया. और इन्हीं संचार माध्यमों के द्वारा संपूर्ण विश्व आज नजदिक आ गया है. एक भी घटना यदि घटित होती है तो समस्त विश्व में घटित घटना पल भर में पहुँच जाती है. हमारे ही परिवेश में घटित घटनाओं का पता हमें नहीं चलता अपितु इन्हीं संसाधनों के द्वारा हम सभी घटनाओं का जान सकते हैं. 21 वीं सदी में मनुष्य संचार माध्यमों से एक दूसरे के पास आता नजर आता है. वस्तुतः इन जनसंचार माध्यमों को हम तीन रूपों में बाँट सकते हैं.

1. मुद्रित माध्यम
2. श्राव्य माध्यम
3. दृक माध्यम.

मुद्रित माध्यम में समाचार, पत्र पत्रिकाओं का आश्रय लेकर जनसंचार माध्यमों में काफी मददगार साबित होते हैं. श्राव्य माध्यम में आकाश वाणी, एफ. एम, टेलीफोन, दृश्य माध्यम दूरदर्शन और इंटरनेट सर्वोपरी है. इन्फोमेशन टेक्नोलॉजी की शुरुआत भले ही अमरिका में हुई हो, भारत की मदद के बिना वह आगे नहीं बढ़ सकती थी. गूगल के मुख्य कार्यकारी एरिक स्मिट ने कुछ महिने पहिले यह कर के जबरदस्त हलचल मचा दी थी. कि आनेवाले पाँच से दस साल के भीतर भारत दुनिया का सबसे बड़ा इंटरनेट का बाजार बन जाएगा. उन्होंने यह भी कहा कि कुछ बरसों में

इंटरनेट पर जिन तीन भाषाओं का दबदबा होगा वे हैं- हिन्दी, मैडरिन और इंग्लिश. 1. पराआधुनिक युग में तकनीकी क्षेत्र में नये - नये परिवर्तन हो रहे हैं. इन्हीं परिवर्तनों के कारण जनसंचार और तकनीकी में हिन्दी का उज्वल भविष्य है. जनसामान्यों की भाषा होने के कारण तमाम लोग इस भाषा से अपने आप जुड़ जाते हैं.

राष्ट्रीयता के लिए तीन बातें अत्यंत महत्वपूर्ण होती हैं

1. राष्ट्रगान
2. राष्ट्रध्वज
3. राष्ट्रभाषा

इनमें भाषा का भी महत्वपूर्ण स्थान होता है. और भाषा का इतिहास साक्ष्य देता है हिन्दी भाषा ने एवं हिन्दी साहित्यकारों ने अपने अपने मंच से देश की सेवा की. राष्ट्रीयता के निर्माण में न केवल अपने आप बल्कि अन्य भाषाओं को भी अपने में समेटते हुए विकास की दिशा निर्धारित करती रही है. स्वाधीनता आंदोलन के पश्चात हिन्दी को नई पृष्ठभूमियाँ प्राप्त होती गयी और हिन्दी ने फारसी, अरबी, अंगरेजी, देशज, विदेशी शब्दों का आत्मसात कर लिया जैसे राजभाषा, राष्ट्रभाषा, साहित्य की भाषा, मातृभाषा आदि के रूपों के साथ जनसंचार की भाषा का भी निर्वहन किया. आपसी भाईचारा, भावना, संवेदना को भी एक दुसरो के साथ संपर्क बनाए रखने में भी सहायक सिद्ध हुई. मुद्रित संसाधनों पर विचार करते हैं तो समाचार पत्र एवं पत्रिकाओं का प्रारंभ आधुनिक युग से हुआ. शुरूआती दौर में पाठकों की अभिरूचि और ग्राम से नगर, से देश तक. समाचार पत्र के विभिन्न अंग कर दिए गए.

1. मुख्य समाचार
2. राजनीतिक समाचार
3. खेल जगत के समाचार
4. सिनेमा के समाचार
5. साहित्यिक समाचार आदि विषयों पर समाचार आधारित होते हैं. हिन्दी के समाचार पत्रों में सहारा, समय, नवभारत टाइम्स, जागरण भास्कर, आदि. जिस प्रकार मुद्रित साधनों को देखा जाता है ठीक उसी प्रकार श्राव्य माध्यमों को भी देखा जाता है. आकाशवाणी की महत्ता से हम सभी परिचित

हैं. मनोरंजन एवं शिक्षा का उत्तम परिचायक बन कर हमारे सामने आता है. शिक्षित हो या अशिक्षित सभी लोगों तक पहुँचना ही आकाशवाणी का मुख्य प्रयोजन हुआ करता था. गाँव हो या हो शहर हर क्षेत्र तक जनबोली के रूप के साथ साथ हिन्दी प्रसारण भी किया जाता है. समय तालिका को अनिवार्य रूप से निभाने का भी प्रयास किया जाता है.

जनसंचार माध्यमों को और अधिक प्रभावशाली एवं सशक्त बनाने के लिए दृक श्राव्य माध्यम अर्थात् दूरदर्शन का स्थान सर्वोपरी है. प्रारंभ में दूरदर्शन की सीमाएं अत्यल्प थी. किसानों को मौसम की जानकारी प्रस्तुत की जाती थी. उस समय के टी.वी. कृष्णधवल हुआ करते थे. उसका आकार भी काफी बड़ा था. रामायण और महाभारत के कारण दूरदर्शन के श्रोताओं की संख्या बढ़ गई. धीरे - धीरे मनोरंजन के साथ तमाम क्षेत्रों का प्रसारण बढ़ गया. खेल, ज्ञानवर्धक एवं एज्युकेशनल सभी जानकारीयों को प्रसारित करने का मानस दूरदर्शन का था. आज कई प्रकार के चैनल्स हैं जिसमें धर्मपरक, नीतिपरक, मानवतावादी विचारों को प्रसारित किया जाता है. फिल्म एक ऐसा सशक्त माध्यम माना जाता है जो केवल धर्म की बातों को ही उजागर नहीं करता अपितु परिवार को संजोने में भी उसका हाथ है. डॉ. ऋषभ देव शर्मा के अनुसार फिल्म के माध्यम से भी हिन्दी को वैश्विक स्तर पर सम्मान प्राप्त हो रहा है. आज अनेक फिल्मकार भारत ही नहीं युरोप, अमरिका और खाड़ी देशों के हिन्दी सिनेमा ऑस्कर तक पहुँच रहा है. दुनिया की संस्कृतियों को निकट लाने के क्षेत्र में निश्चय ही इस संचार माध्यम का योगदान चमत्कार कर सकता है. यदि मनोरंजन और अर्थ उत्पादन के साथ साथ सार्थकता का भी ध्यान रखा जाए, जो सिनेमा सर्वाधिक प्रभावशाली माध्यम सिद्ध हो सकता है. इसमें संदेह नहीं कि सिनेमा ने हिन्दी की लोकप्रियता भी बढ़ाई और व्यावहारिकता भी: ... 2 केवल इन तीनों जनसंचार से कार्य नहीं होता अपितु वर्तमान के तकनीकी विकास के साथ - साथ अपना रूप बदल रहा है उसका बदला हुआ रूप कम्प्यूटर के विकास साथ जुड़ा है. जैसे सायबर स्पेस या इंटरनेट का आविष्कार. इंटरनेट वस्तुतः एक ऐसा मायाजाल है जो उंगलियों के इशारों पर सभी

---

के प्रश्नों के जबाब तुरंत देने में समर्थ हैं. इन सभी साधनों की भाषा हिंदी है. इसी के साथ - साथ आकाशवाणी को भी विविध चैनलों का निर्माण करना पडा है. न्यूज ऑन ए आय आर डॉट कॉम जैसी वेब का निर्माण करना पडा है. दूरदर्शन को भी निजी चैनलों के साथ विविध चैनलों की शुरूआत करनी पडी है. स्पष्ट है कि इनमें हिन्दी भाषा को विकास के लिए सुअवसर हैं. और समय के साथ नई दिशा में विकास निर्धारित करते हुए इन चुनौतियों का सामना करना आवश्यक है.

कार्यालयीन उपयोग के लिए अक्षर, संगम, देवबेस, शब्दरत्न, आलेख, एम. एल वर्क्स, सुलेख, मल्टीवर्ड, वाईस्क्रिप्ट आदि निर्माण हुआ है. किन्तु हिन्दी भाषा के सामान्य उपयोग के लिए सूलिपि जैसे सॉफ्टवेअर का निर्माण होना आवश्यक है. आशिष गर्ग ने कहा है कि भारतीय भाषाओं में प्रसारण के लिए उचित साधनों का होना बहुत जरूरी है जो कि भारतीय भाषाओं में सूचारू रूप से कार्य कर सके. यह काम दुनिया के कई देशों में किया जा चुका है. जैसे कि जापान, कोरिया लगभग सारे यूरोपीय देश एवं हमारा पड़ोसी चीन जहाँ सबकुछ मैडरिन में सूचारू तरह से चल रहा है. जब यह काम वहाँ हो सकता है तो हमारे यहाँ क्यों नहीं हो सकता.<sup>3</sup>

वास्तव में हिन्दी की मुद्रित सामग्री को जब भी हम पढते हैं तो हमें समस्या आती है लिपि की. लिपि की समस्या के कारण कई बार फॉण्ट साइज़ मॅच नहीं हो पाती जिस कारण तमाम पाठकों को समस्याओं से झूझना पडता है. दुनिया के बाजारवाद में हिन्दी को अपनी अस्मिता से बनाए रखना है तो अपना विकास निश्चित तौर पर करना होगा. ई - शिक्षा, ई - प्रशासन, ई - कॉमर्स आदि की प्रणाली को आत्मसात कर भारत की तमाम भाषाओं को सुदृढ बनाने के लिए प्रयासरत होना नितांत अनिवार्य होगा.

संदर्भ

1. बालेन्दु शर्मा - अभिव्यक्ति 2007
2. डॉ. ऋषभदेव शर्मा - भूमंडलिकरण की चुनौतियाँ संचार माध्यम और हिन्दी का सन्दर्भ
3. आशिष गर्ग - अभिव्यक्ति 2007

ISSN NO  
2454-7719

# International Journal of Computer Research & Technology ( IJCRT )

A Peer Reviewed Half Yearly Research Journal

Vol -6 Issue - 1  
January- June, 2020

Special Issue

Proceeding of the 1<sup>st</sup> Online National E-Conference on  
"Ongoing Research On Computer Science"  
held on 27<sup>th</sup> May 2020.

Editor in Chief  
Dr.B.H.Barhate

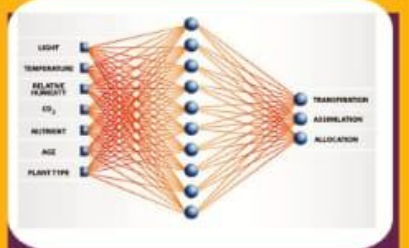

Department of Computer Science and Information Technology  
**Bhusawal Arts Science & P.O.Nahata Commerce College,**  
**Bhusawal - 425 201 Maharashtra**